


Ref : AN\_RF\_007 V1.0



APPLICATION  
NOTE

Beanair Wireless sensor networks deployment guideline

*Beanair – 1, mail Gay Lussac - 95000 Neuville-sur-Oise – France*

	<b>BeanAir</b> 1, mail Gay Lussac 95000 Neuville-Sur-Oise France	Draft Version : V1R0	Draft Reference : AN_RF_007
		<b>Beanair Wireless sensor networks  deployment guideline</b>	


<b>DOCUMENT</b>			
<b>Document number</b>	/	<b>Version</b>	V1R0
<b>External Reference</b>	Application Note	<b>Last Publication date</b>	07/08/2010
<b>Author</b>	Christophe Dontegreuil		
<b>Document code</b>		<b>Project Code</b>	
<b>Document Name</b>	Beanair Wireless sensor networks deployment guideline		

<b>VALIDATION</b>			
Function	Recipients	Validation	Information
<b>Writer</b>	Jonathan DINIS		
<b>Reader</b>	Philippe FROMON		X
<b>Approbation</b>	Maneli PARSY	X	

<b>DIFFUSION</b>			
Function	Recipients	Validation	Action
<b>Reader 1</b>	Philippe FROMON, Embedded software engineer	X	
<b>Reader 2</b>	Christophe Dontegreuil, technical support engineer	X	

<b>Updates</b>			
Version	Date	Author	Evolution & Status
1.0	22/04/2010	Jonathan DINIS	Document creation
1.1	07/05/2011	Christophe Dontegreuil	Appendices added


Ref: Application note NA_007	Publication date : 07/08/2010		Page : 1 / 36
---------------------------------	-------------------------------	--	---------------

	<b>BeanAir</b> 1, mail Gay Lussac 95000 Neuville-Sur-Oise France	Draft Version : V1R0	Draft Reference : AN_RF_007
		<b>Beanair Wireless sensor networks  deployment guideline</b>	




1.	TECHNICAL SUPPORT .....	5
2.	VISUAL SYMBOLS DEFINITION .....	6
3.	ACRONYMS AND ABBREVIATIONS .....	7
4.	RELATED DOCUMENTS .....	8
5.	INTRODUCTION .....	10
6.	WIRES VS WIRELESS .....	11
7.	RADIO CHANNEL BASICS .....	13
7.1	The 2.4-GHz ISM Band - Living with Your Neighbours.....	13
7.2	Transmit Power, Receive Sensitivity and Range .....	14
8.	ANTENNA OPTIONS .....	16
8.1	Products with Internal Antenna (Ecosensor product Lines) .....	16
8.2	Products with External antenna .....	17
9.	ANTENNA PROPERTIES AND TYPES.....	20
9.1	Antenna Directivity .....	20
9.2	Antenna Issues and Types.....	21
9.2.1	Isotropic Antenna.....	22
9.2.2	Half-Wave Dipole Antenna .....	22
9.2.3	Yagi Antenna .....	22
9.3	Antenna Gain .....	24
9.4	Antenna Polarisation .....	24
9.5	Antenna Commissioning .....	25
10.	REFLECTIONS, OBSTRUCTIONS AND MULTIPATH.....	26
11.	DEPLOYMENT GUIDELINES .....	28
11.1	General Guidelines.....	28
11.2	Multipath and Fade Margins.....	28
11.3	Open Space Guidelines .....	29

Ref: Application note NA_007	Publication date : 07/08/2010		Page : 2 / 36
---------------------------------	-------------------------------	--	---------------

	<b>BeanAir</b> 1, mail Gay Lussac 95000 Neuville-Sur-Oise France	Draft Version : V1R0	Draft Reference : AN_RF_007
		<b>Beanair Wireless sensor networks  deployment guideline</b>	

11.4 Indoor Environment Guidelines.....	29
12. POINT-TO-POINT LINK GUIDELINES .....	31
13. SHARING CHANNELS WITH OTHER RADIO SYSTEMS.....	33
14. DEPLOYMENT CHECKLIST.....	36

	<b>BeanAir</b> 1, mail Gay Lussac 95000 Neuville-Sur-Oise France	Draft Version : V1R0	Draft Reference : AN_RF_007
		<b>Beanair Wireless sensor networks  deployment guideline</b>	

### *Disclaimer*

The information contained in this document is the proprietary information of Beanair.

The contents are confidential and any disclosure to persons other than the officers, employees, agents or subcontractors of the owner or licensee of this document, without the prior written consent of Beanair Ltd, is strictly prohibited.

Beanair makes every effort to ensure the quality of the information it makes available. Notwithstanding the foregoing, Beanair does not make any warranty as to the information contained herein, and does not accept any liability for any injury, loss or damage of any kind incurred by use of or reliance upon the information.

Beanair disclaims any and all responsibility for the application of the devices characterized in this document, and notes that the application of the device must comply with the safety standards of the applicable country, and where applicable, with the relevant wiring rules.


Beanair reserves the right to make modifications, additions and deletions to this document due to typographical errors, inaccurate information, or improvements to programs and/or equipment at any time and without notice.

Such changes will, nevertheless be incorporated into new editions of this document.

Copyright: Transmittal, reproduction, dissemination and/or editing of this document as well as utilization of its contents and communication thereof to others without express authorization are prohibited. Offenders will be held liable for payment of damages. All rights are reserved.

Copyright © Beanair Ltd. 2010.

Ref: Application note NA_007	Publication date : 07/08/2010		Page : 4 / 36
---------------------------------	-------------------------------	--	---------------

	<b>BeanAir</b> 1, mail Gay Lussac 95000 Neuville-Sur-Oise France	Draft Version : V1R0	Draft Reference : AN_RF_007
		<b>Beanair Wireless sensor networks  deployment guideline</b>	

## 1. TECHNICAL SUPPORT

---

For general contact, technical support, to report documentation errors and to order manuals, contact *Beanair Technical Support Center* (BTSC) at:

[tech-support@beanair.com](mailto:tech-support@beanair.com)

For detailed information about where you can buy the Beanair equipment/software or for recommendations on accessories and components visit:

[www.beanair.com](http://www.beanair.com)

To register for product news and announcements or for product questions contact Beanair's Technical Support Center (BTSC).




Our aim is to make this user manual as helpful as possible. Keep us informed of your comments and suggestions for improvements.

Beanair appreciates feedback from the users of our information.

Ref: Application note NA_007	Publication date : 07/08/2010		Page : 5 / 36
---------------------------------	-------------------------------	--	---------------

## 2. VISUAL SYMBOLS DEFINITION


---

<i>Visuel</i>	<i>Définition</i>
	<i>Caution or Warning – Alerts the user to important points about Beanair wireless sensor networks (WSN), if these points are not followed, the equipment /software may fail or malfunction.</i>
	<i>Danger – This information MUST be followed or catastrophic equipment failure or bodily injury may occur.</i>
	<i>Tip or Information – Provides advice and suggestions that may be useful when installing Beanair Wireless Sensor Networks.</i>

### 3. ACRONYMS AND ABBREVIATIONS

---

<b>ISM</b>	Industrial Scientific and Medical
<b>LR-WPAN</b>	Low Rate Wireless Personal Area Network
<b>WLAN</b>	Wireless Local Area Network
<b>AP</b>	Access Point
<b>PHY</b>	Physical Layer
<b>MAC</b>	Medium Access Control
<b>DSSS</b>	Direct Sequence Spread Spectrum
<b>FHSS</b>	Frequency Hopping Spread Spectrum
<b>CCK</b>	Complementary Code Keying
<b>PBCC</b>	Packet Binary Convolutional Code
<b>OFDM</b>	Orthogonal Frequency-Division Multiplexing
<b>O-QPSK</b>	Offset quadrature phase-shift keying
<b>(D)BPSK</b>	(Differential) binary phase shift keying
<b>(D)QPSK</b>	(Differential) quadrature phase-shift keying
<b>QAM</b>	Quadrature amplitude modulation
<b>CSMA-CA</b>	Carrier sense multiple access with collision avoidance
<b>CCA</b>	Clear Channel Assessment
<b>CCA-CS</b>	Clear Channel Assessment - Carrier Sense
<b>CCA-ED</b>	Clear Channel Assessment - Energy Detect
<b>LQI</b>	Link Quality Indicator
<b>ED</b>	Energy Detect
<b>BER</b>	Bit Error Rate
<b>SNR</b>	Signal to Noise Ratio
<b>PER</b>	Packet Error Rate

	<b>BeanAir</b> 1, mail Gay Lussac 95000 Neuville-Sur-Oise France	Draft Version : V1R0	Draft Reference : AN_RF_007
		<b>Beanair Wireless sensor networks  deployment guideline</b>	

## 4. RELATED DOCUMENTS

---

- [1] IEEE Std 802.15.4-2003, LR-WPANs
- [2] IEEE Std 802.11-1999 Edition (R2003), WLAN
- [3] IEEE Std 802.11b-1999 (R2003), WLAN
- [4] IEEE Std 802.11b-1999/Cor 1-2001, WLAN
- [5] IEEE Std 802.11g-2003, WLAN
- [6] IEEE Std 802.15.1-2005, WPANs (Bluetooth)
- [7] Petrova M., Riihijarvi J., Mahonen P., and Labella S., "Performance study of IEEE 802.15.4 using measurements and simulations". Wireless Communications and Networking Conference, 2006. WCNC 2006. IEEE
- [8] Sikora Axel. "Compatibility of IEEE802.15.4 (ZigBee) with IEEE802.11 (WLAN), Bluetooth, and Microwave Ovens in 2.4 GHz ISM-Band"
- [9] Sikora A., and Groza V.F., "Coexistence of IEEE802.15.4 with other Systems in the 2.4 GHz-ISM-Band". IEEE Instrumentation and Measurement Technology Conference, IMTC 2005
- [10] Shuaib K., Boulmal M., Sallabi F., and Lakas A., "Co-existence of ZigBee and WLAN - a performance study". Wireless and Optical Communications Networks, 2006. IFIP International Conference
- [11] Application Note "How to extend your wireless range ? ". Beanair
- [12] " ZigBee and Wireless Radio Frequency Coexistence". ZigBee Alliance. June 2007
- [13] Shin S.Y., Choi S., Park H.S., and Kwon W.H., " Packet Error Rate Analysis of IEEE 802.15.4 under IEEE 802.11b Interference". Wired/Wireless Internet Communications. WWIC May 2005
- [14] Shin S.Y., Park H.S., and Kwon W.H., "Packet Error Rate Analysis of IEEE 802.15.4 under Saturated IEEE 802.11b Network Interference". IEICE Transactions on Communications 2007
- [15] Shin S.Y., Park H.S., Choi S., and Kwon W.H., "Packet Error Rate Analysis of ZigBee Under WLAN and Bluetooth Interferences". Wireless Communications, IEEE Transactions. August 2007

Ref: Application note NA_007	Publication date : 07/08/2010		Page : 8 / 36
---------------------------------	-------------------------------	--	---------------




**BeanAir**  
1, mail Gay Lussac  
95000 Neuville-Sur-Oise  
France

Draft Version : V1R0

Draft Reference :  
AN\_RF\_007

**Beanair Wireless sensor networks  
deployment guideline**

	<b>BeanAir</b> 1, mail Gay Lussac 95000 Neuville-Sur-Oise France	Draft Version : V1R0	Draft Reference : AN_RF_007
		<b>Beanair Wireless sensor networks  deployment guideline</b>	


## 5. INTRODUCTION

---

The IEEE 802.15.4 wireless network standards have paved the way for a revolution in the implementation of PANs (Personal Area Networks), with the traditional wiring used to connect sensors and switches being replaced with radio links. This wireless solution is hugely attractive in helping to reduce construction costs of new buildings.

For the majority of installations, the siting of individual Beanair® WSN will be done without expert radio knowledge. This Application Note outlines the basic considerations and rules to enable successful installations in such cases.

Ref: Application note NA_007	Publication date : 07/08/2010		Page : 10 / 36
---------------------------------	-------------------------------	--	----------------

	<b>BeanAir</b> 1, mail Gay Lussac 95000 Neuville-Sur-Oise France	Draft Version : V1R0	Draft Reference : AN_RF_007
		<b>Beanair Wireless sensor networks  deployment guideline</b>	

## 6. WIRES VS WIRELESS

---

The notion of a wired link is a familiar one - a cable joins two connectors, and a link is made. The link is normally broken by disconnection at either end (or rarely if the intervening cable is broken, perhaps by accident). Thus, the physical environment of a wired link (e.g. the office) usually plays little or no part in determining the state of the link.

For a radio link, the situation is different. There is no cable to act as a secure and reliable signal path. The link must be made across free-space, through walls, people and other obstructions. This environment may be constantly changing, such as in a busy working area with people moving around. Furthermore, the environment may already contain other wireless systems that seek to "share" the same airwaves as the system to be deployed. In short, in wireless system deployment, there is usually little or no control over the deployment environment, which can vary widely.

So, what can be done to ensure that your network is deployed efficiently? First consider listening to an FM radio. Here you are enjoying the result of an established radio link deployment. The engineers who built this system have used high towers on which they have located their transmit antennae. They have engineered the system to ensure (as much as is reasonably possible) that the radio signal reaches you in good enough shape for clear audio reproduction. They have considered walls, trees, hills and all manner of things that could be located between the transmit tower and you.

The fact that you are listening means they have deployed their network effectively.

The successful deployment of a wireless IEEE 802.15.4 network requires us to consider some of the same deployment issues as above, but on a smaller physical scale. The advice we give here is pragmatic and realistic, acknowledging that a reliable system must be achieved within limited deployment time.

Ref: Application note NA_007	Publication date : 07/08/2010		Page : 11 / 36
---------------------------------	-------------------------------	--	----------------




**BeanAir**  
1, mail Gay Lussac  
95000 Neuville-Sur-Oise  
France

Draft Version : V1R0

Draft Reference :  
AN\_RF\_007

**Beanair Wireless sensor networks  
deployment guideline**

	<b>BeanAir</b> 1, mail Gay Lussac 95000 Neuville-Sur-Oise France	Draft Version : V1R0	Draft Reference : AN_RF_007
		<b>Beanair Wireless sensor networks  deployment guideline</b>	

## 7. RADIO CHANNEL BASICS

---


This chapter introduces some of the basic concepts of radio communication, particularly those relevant to wireless networks.

### 7.1 THE 2.4-GHZ ISM BAND - LIVING WITH YOUR NEIGHBOURS

---

Beanair's wireless microcontrollers are designed to operate in the 2.4-GHz radio band, which is available worldwide. This band, also known as an ISM (Industrial, Scientific and Medical) band, has rules which allow many different systems to use it at the same time. An IEEE 802.15.4 network may have to share its frequency space with systems such as Wi-Fi (e.g. IEEE802.11b/g wireless LAN), video distribution, Bluetooth and cordless telephones. However, the IEEE 802.15.4 protocol is well suited to shared-band operation. It has 16 separate channels that allow the system to "choose" a channel that is not being used by either other IEEE 802.15.4 networks or other 2.4-GHz deployed systems. More information on sharing the frequency band is provided in [Chapter 13](#). Once set up to use one of these channels, the IEEE 802.15.4 protocol provides a reliable radio link. The protocol employs a robust modulation scheme that is not easily disturbed by other 2.4-GHz band users. Furthermore, the radio modem uses Direct Sequence Spread Spectrum (DSSS) coding that improves transmitter-to-receiver range and offers some protection against interference. We have already raised the issue that the radio link can be interrupted by a variety of factors. Received data is checked for corruption (i.e.errors) - using instantaneous handshaking (message checking), the receiving device can acknowledge a correct or incorrect message by transmitting a short return message. With this feature enabled, any unsuccessful messages can be re-sent until they eventually reach their recipient.

Ref: Application note NA_007	Publication date : 07/08/2010		Page : 13 / 36
---------------------------------	-------------------------------	--	----------------

	<b>BeanAir</b> 1, mail Gay Lussac 95000 Neuville-Sur-Oise France	Draft Version : V1R0	Draft Reference : AN_RF_007
		<b>Beanair Wireless sensor networks  deployment guideline</b>	

## 7.2 TRANSMIT POWER, RECEIVE SENSITIVITY AND RANGE

The concepts of "transmit power", "receive sensitivity" and "range" are very familiar to radio engineers and are fundamental to the operation of a radio link. We will now explore them and see their importance in a wireless network installation.

We will consider these concepts by taking the analogy to an audio system:

- **Transmit Power:** This is similar to the power that is delivered to a speaker in a Hi-Fi system - the more power supplied, the stronger the sound signal (and the further it will travel and still be heard).
- **Receive Sensitivity:** This is analogous to how well a person's hearing can detect the sound signal.
- **Range:** This is equivalent to the maximum distance the sound signal can travel and still be intelligibly heard. For example, if the sound signal is a news report, there is a distance from the speaker at which the sound can still be heard, but beyond this limit the content of the report becomes indiscernible - this distance defines the range.


For an IEEE 802.15.4-based radio link, the radio transmit power is limited by the local regulatory radio regulations. Beanair RF module is designed to comply with these regulations. In radio terms, the transmit power of a high-power module is approximately 100 mW, a hundred times that of a standard module, which is 1 mW.

At the receive end of a radio link, the minimum power level that can be detected is approximately 1/1000000000 of 1 mW (10<sup>-9</sup> mW or 10<sup>-12</sup> W). Thus, radio receivers require only a tiny amount of radio energy to discern a usable signal. This factor is used to excellent effect in a radio network.

Due to the very small numbers involved, it is convenient to use a logarithmic scale to express signal levels. This method involves a calculation based on the **ratio** of two signal levels, the result expressed in the unit of the decibel (dB) - the calculation is given by the expression  $10\log(P_o/P_r)$ , where  $P_o$  is the power level of interest and  $P_r$  is a reference power level. Therefore, the reference power level must be stated and is normally incorporated into the unit - dBm means dB referred to 1 mW, while dBw means dB referred to 1 W. Hence, 0 dBm is 1 mW, while 20 dBm is 100 mW (and corresponds to -10 dBw).

An important concept in radio networks is "line-of-sight" (LOS). As an example, consider a radio signal broadcast in Space from one satellite to another satellite. If the two satellites can visually "see" each other, they have a "line-of-sight". In a wireless network, a LOS link means that the two nodes can "see" each other, but a non-LOS link is also possible where the two nodes cannot physically "see" each other but can still communicate (Cf. [Chapter 10](#) for further informations). Taking the ideal case of the two satellites once again, assuming they both have antennae that radiate equally in all directions with no losses, the range between them is determined by [Equation 1](#) below.

Ref: Application note NA_007	Publication date : 07/08/2010		Page : 14 / 36
---------------------------------	-------------------------------	--	----------------

	<b>BeanAir</b> 1, mail Gay Lussac 95000 Neuville-Sur-Oise France	Draft Version : V1R0	Draft Reference : AN_RF_007
		<b>Beanair Wireless sensor networks  deployment guideline</b>	

$$R = \frac{\lambda}{4\pi} \sqrt{\frac{P_{tx}}{P_{rx}}}$$

*Equation 1*

where  $R$  = Achievable range, in meters

$\lambda$  = Free-space wavelength, in meters

$P_{tx}$  = Transmitter power, in Watts

$P_{rx}$  = Receiver sensitivity, in Watts

Using approximate values for typical Beanair RF Transceiver performance measurements, we can calculate that equipping the satellites with standard RF Transceiver gives a range of around 700 meters. Using high-power RF Transceiver, the increase in transmit power together with an improvement in receive sensitivity pushes this range up ten-fold to nearly 7 kilometers.








The above calculations are based on "free-space" radio wave propagation (in a perfect vacuum) and use antennae that are considered to be "isotropic" (radiate equally in all directions). In reality, there are many real-world issues that challenge these assumptions and a different result may be obtained.

Ref: Application note NA_007	Publication date : 07/08/2010		Page : 15 / 36
---------------------------------	-------------------------------	--	----------------

## 8. ANTENNA OPTIONS

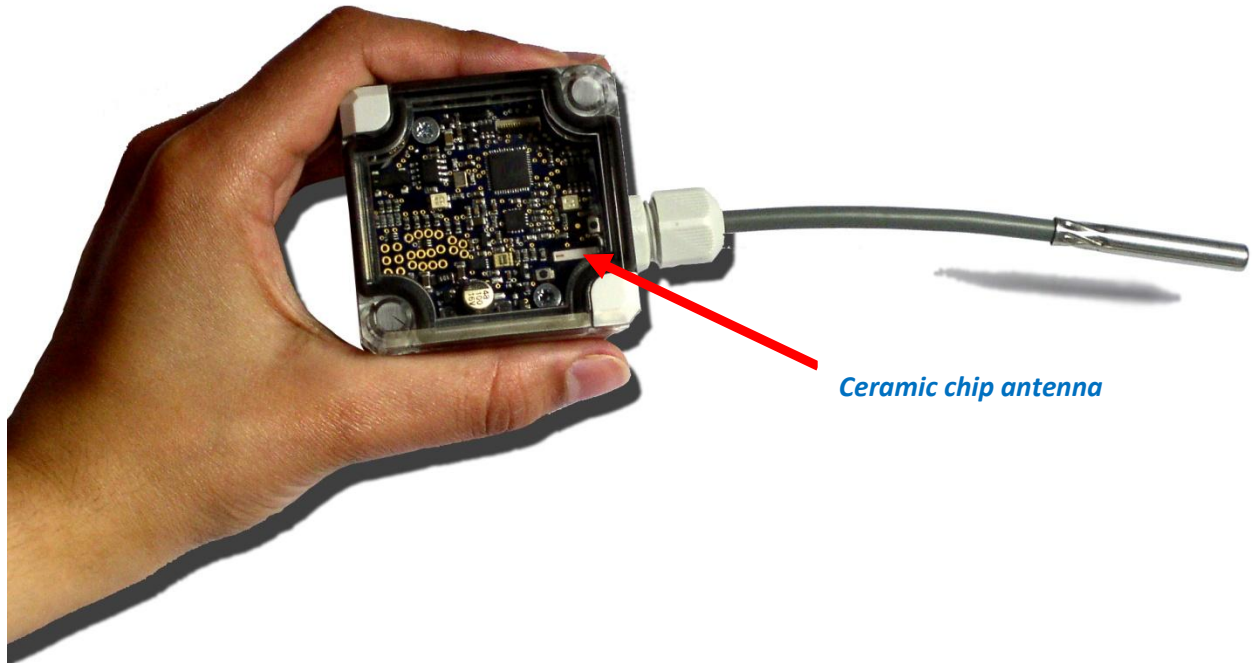
Radio systems must both launch radio energy from their transmitter and capture energy from the airwaves into their receiver - for this they use an antenna. The correct choice and connection of the antenna is crucial to maximising performance. Thus this topic warrants detailed consideration.

The following table shows the antenna technology used on our products:

Antenna Technology	BeanGateway Indoor	BeanGateway Outdoor	BeanDevice® SUN-T BeanDevice® SUN-BN BeanDevice SUN-TIR BeanDevice SUN-BN	BeanDevice AN-XX	BeanDevice AX-3D BeanDevice HI-INC BeanDevice AX-3DS BeanDevice AX-IN	BeanDevice TSI	BeanDevice TH
PIFA Antenna (Internal antenna)							
Radome Antenna							
External Omnidirectional antenna with N-Type plug							
External Omnidirectional antenna with RPSMA plug							

### 8.1 PRODUCTS WITH INTERNAL ANTENNA (ECOSENSOR PRODUCT LINES)

The integrated antenna is a small ceramic chip component that extends from the screening can that surrounds the chip and associated components. While this antenna is self-contained, we must ensure that it protrudes from the surrounding ground plane (see [Figure 1](#) below). It is worth noting that the principle of reciprocity applies here - this means that the antenna works in the same way in transmit and receive modes, with a simple reversal of the energy flow.




*Figure 1: A BeanDevice SUN-T with an internal ceramic chip antenna*

## 8.2 PRODUCTS WITH EXTERNAL ANTENNA

Beanair products range also includes RF connector and external antenna (see [Figure 2](#), [Figure 2.1](#), [Figure 2.2](#) below).



*Figure 2: BeanDevice AN-XX with N-Type Antenna*

	<b>BeanAir</b> 1, mail Gay Lussac 95000 Neuville-Sur-Oise France	Draft Version : V1R0	Draft Reference : AN_RF_007
		<b>Beanair Wireless sensor networks deployment guideline</b>	



*Figure 2.1: BeanDevice TSI with RPSMA Antenna*




*Figure 2.2: BeanDevice GYR-3D with Radome antenna*

The available RF connectors include N-type, Radome Antenna and reverse polarity SMA. These products offer a huge amount of flexibility in the choice and location of the antennae in a wireless network, but we must be careful in our choices. Some key points to bear in mind are:

- **Connectors:** The SMA/RPSMA connector is a specialist RF connector designed to work well at the required 2.4-GHz frequency (in fact, special versions of this connector are available to work well beyond 40 GHz). This connector is particularly suitable for product evaluation and measurement, as it is widely available on antennae and test equipment. N-Type antennas are more adapted for industrial environment; these antennas are robust and waterproof (IP66/IP67). For embedded applications, Radome antenna will be more suitable. Radome antennas are used on Smartsensor products lines.

Ref: Application note NA_007	Publication date : 07/08/2010		Page : 18 / 36
---------------------------------	-------------------------------	--	----------------

	<b>BeanAir</b> 1, mail Gay Lussac 95000 Neuville-Sur-Oise France	Draft Version : V1R0	Draft Reference : AN_RF_007
		<b>Beanair Wireless sensor networks  deployment guideline</b>	

- **Antenna frequency range:** There are an increasing number of connectable antennae available for all kinds of wireless systems. It is very important that an antenna is selected that is designed to operate in the 2400-2500 MHz ISM band. The antenna is a tuned component and antennae designed to work in other systems, such as mobile phones at 900 MHz, will not function correctly and cause severe range problems.
  
- **Cables:** There are a number of cables available that are designed for 2.4-GHz operation. They are co-axial cables designed with low-loss dielectric insulation, plated inner conductor and high-density or double-braided outer shielding. If cable must be used to relocate an antenna, as is beneficial in some situations, then it is important to use suitable cable. In addition, the cable must use the correct co-axial connector.



*In order to avoid installation and (later) reliability issues, Beanair recommends that cables are bought as completed and tested sub-assemblies designed for use at the relevant frequency.*

The recommended antennae are typically low-loss, dipole types. As a general rule, this type of antenna is about 2 to 4 times more efficient than the integral ceramic type, achieving up to double the free-space range of the latter. The dipole antenna is much bigger than the tiny ceramic antenna. There are many situations in which small size is important (particularly in hand-held equipment) but, generally speaking, good performance does not come with small antenna size.

It is possible to attach an antenna directly to the module connector, but this is not recommended for situations where there could be mechanical stress on the antenna which could potentially damage the module. As with the ceramic antenna, it is important to mount the connectable antenna away from other metallic structures, obeying the same 6-cm clearance rule. It is also unlikely that the larger antennae would be placed inside the equipment case.



*Beanair provides any type antennas & coaxial cable as an option accessory. Don't hesitate to ask our accessories catalog.*

Ref: Application note NA_007	Publication date : 07/08/2010		Page : 19 / 36
---------------------------------	-------------------------------	--	----------------

## 9. ANTENNA PROPERTIES AND TYPES

This section introduces certain key antenna properties and the main types of antenna.

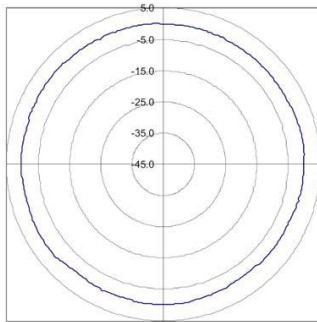
### 9.1 ANTENNA DIRECTIVITY

Have you ever wondered why a TV satellite dish needs to be pointed very precisely in the direction of the broadcaster's satellite? The dish is a reflector antenna – radio waves arriving parallel to the axis of the antenna are collected by the dish (normally part of a paraboloid) and reflected to a common focus on the axis, where they are converted into electrical signals. This leads to a particular sensitivity to radio waves arriving from one specific direction, from one small patch of sky - the antenna is said to be highly directive. As the diameter of a dish antenna is increased, the antenna becomes more directive. Thus, a radio telescope, is much more directive than a satellite dish - this enables astronomers to isolate an extremely tiny patch of sky for observation, such as that encompassing a distant galaxy.

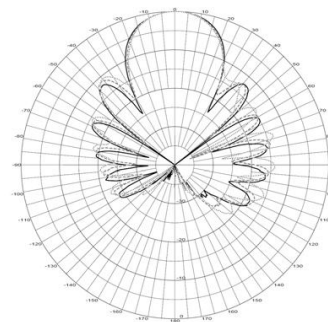


*Figure 3: A Large Directive Antenna*

A consequence of a highly directive antenna is that it has very poor sensitivity in other directions. The sensitivity or "directivity" of an antenna can be mapped as a function of the angle of arrival of radio waves - the result is referred to as the "radiation pattern" or "polar diagram" of the antenna. An antenna with equal sensitivity in all directions will result in a spherical radiation pattern, while a highly directional antenna will have a significant "main beam" or "major lobe" (as well as a number of smaller "side lobes") - these are illustrated in [Figure 4](#) below.



*Isotropic Antenna*



*Directive Antenna*

**Figure 4: Radiation Patterns for Isotropic and Directive Antennae**

The "directivity" of an antenna in a certain direction can be thought of as its sensitivity as a receiver in that direction. However, it is easier to think of directivity in terms of the relative power of the antenna in the given direction when used as a transmitter. As a numerical quantity, the directivity is expressed relative to that of an isotropic antenna - that is, an antenna which is equally sensitive (as a receiver) or radiates equally (as a transmitter) in all directions. The directivity of an isotropic antenna in any direction is defined as 1. The directivity of another antenna, in a certain direction, is then stated relative to this isotropic case, with the assumption that both antennae radiate the same total power (integrated over all directions). The directivity is expressed logarithmically in units of "dBi" - decibels, with the "i" indicating with reference to the isotropic antenna. Thus, a directivity of 20 dBi indicates that the antenna radiates 100 times more power than an isotropic antenna in the given direction.

## 9.2 ANTENNA ISSUES AND TYPES

Wireless networks do not normally require the use of highly directive antennae, but there are a number of properties of the antennae that must be considered. These issues are summarized below:

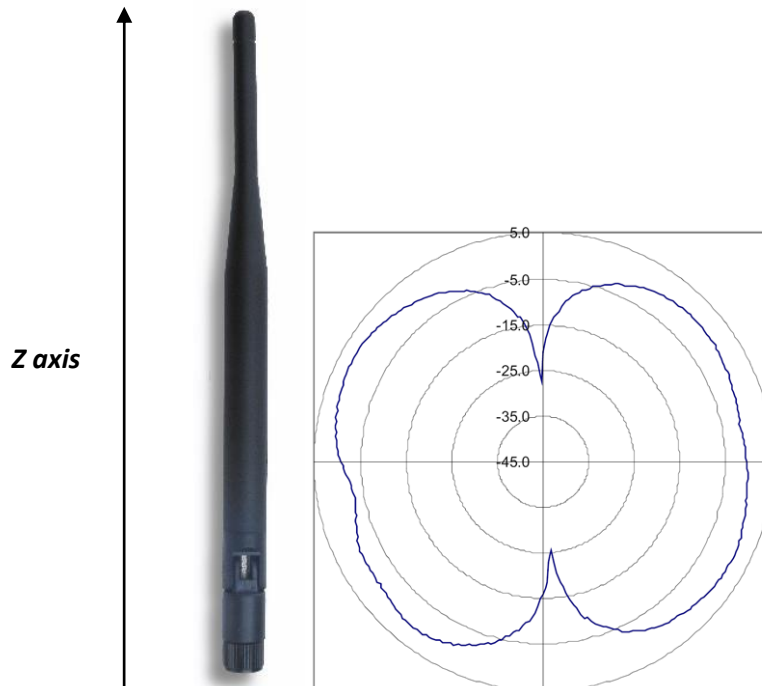
- A single antenna must function well for all likely angles of arrival of radio energy from other nodes.
- The antenna must, in most cases, be small enough to be compatible with a small radio node.
- Local radio regulatory rules may restrict the size of the antenna by setting a limit on the allowed gain (see [Section 9.3](#)).
- Where an antenna can be oriented in a particular direction, it is likely that its direction setting will not be very precise. The main types of antenna are considered in the subsections below.

### 9.2.1 Isotropic Antenna

As already mentioned, an "isotropic" antenna radiates equally in all directions as a transmitter, and is equally sensitive in all directions as a receiver. The antenna radiation pattern is simply a sphere with directivity of unity in all directions, as shown in [Figure 4](#). It is not a real-world antenna and exists only in theory. Its significance is that it provides a reference point for all other antennae - often, antenna directivity and gain are specified in units of "dBi", which defines the relative directivity or gain of the real-world antenna against the theoretical isotropic antenna.

### 9.2.2 Half-Wave Dipole Antenna

[Figure 5](#) below shows the radiation pattern of a half-wave dipole antenna (for the BeanGateway® Indoor antenna example). Note that the dipole radiates in a similar way to the isotropic case close to the horizontal, but has virtually no radiation at the vertical.



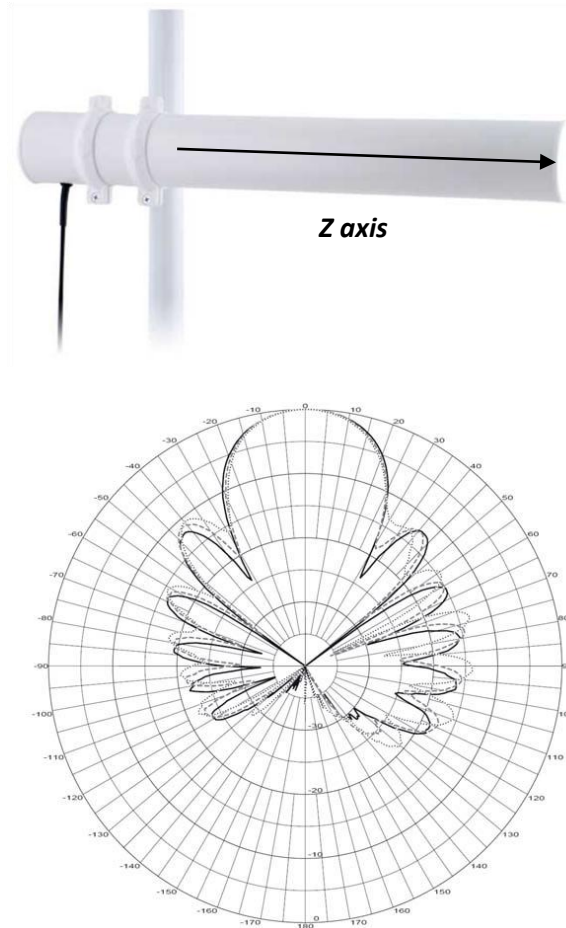
*Figure 5: Half-Wave Dipole Antenna*

### 9.2.3 Yagi Antenna


The Yagi antenna is highly directive. [Figure 6](#) below shows its radiation pattern (for the Telex 2.4-GHz WLAN antenna, in this example). Notice that there is a direction in which the antenna radiates with almost ten times the power of the isotropic antenna.

However, this directivity comes at the expense of power radiated in other directions and for considerably higher cost. Antennae of this type will give significantly more range, but only in one direction, and therefore

are only really suitable for point-to-point links (see [Section 6.5](#)). Another potential benefit is that the system is less susceptible to interfering signals from outside the main beam of the antenna.



**Figure 6: Yagi Antenna**

	<b>BeanAir</b> 1, mail Gay Lussac 95000 Neuville-Sur-Oise France	Draft Version : V1R0	Draft Reference : AN_RF_007
		<b>Beanair Wireless sensor networks  deployment guideline</b>	

### 9.3 ANTENNA GAIN

Antenna gain is simply the antenna directivity taking into account any inefficiencies in the antenna, and is usually expressed in dBi (as for directivity - see above). Antenna inefficiencies can originate in the antenna structure itself, as well as the RF feed and, if fitted, the cable to the antenna. This becomes significant with very small antennae, particularly ceramic types. However, for well-engineered antennae with good RF feeds, it is permissible to consider directivity and gain to be interchangeable. Antennae with positive gains boost the range of the radio system, in the direction that the gain is quoted. Once again, considering the case of the two satellites, as described in [Equation 1](#), if we now assume they have antennae with particular gains in the relevant directions then [Equation 1](#) can be adjusted as shown below:

$$R = \frac{\lambda}{4\pi} \sqrt{\frac{P_{tx} G_1 G_2}{P_{rx}}} \quad \text{Equation 2}$$

where  $R$  = Achievable range, in meters

$\lambda$  = Free-space wavelength, in meters

$P_{tx}$  = Transmitter power, in Watts

$P_{rx}$  = Receiver sensitivity, in Watts

$G_1$  and  $G_2$  = Linear antenna gains for Satellite 1 and Satellite 2 respectively

Often it is simpler to use decibel (dB) quantities, which are routinely quoted in datasheets - in this case, Equation 2 is rewritten as:

$$R = \frac{\lambda}{4\pi} \times 10^{\left(\frac{g_1 + g_2 + P_{tx} - P_{rx}}{20}\right)} \quad \text{Equation 3}$$

where  $R$  = Achievable range, in metres

$\lambda$  = Free-space wavelength, in metres

$P_{tx}$  = Transmitter power, in dBm

$P_{rx}$  = Receiver sensitivity, in dBm

$g_1$  and  $g_2$  = Antenna gains for Satellite 1 and Satellite 2, in dBi, respectively

Note that range increases with higher antenna gain, higher transmit power and better receiver sensitivity.




*Most antennae datasheets quote peak gain in the most favourable direction, so it is worth checking the radiation patterns to see how much variation in gain occurs in different directions.*

### 9.4 ANTENNA POLARISATION

A radio transmission is linearly polarised - that is, the electric and magnetic fields in the radio waves are in fixed orthogonal planes (each containing the direction of wave propagation). This is because the

Ref: Application note NA_007	Publication date : 07/08/2010		Page : 24 / 36
---------------------------------	-------------------------------	--	----------------

	<b>BeanAir</b> 1, mail Gay Lussac 95000 Neuville-Sur-Oise France	Draft Version : V1R0	Draft Reference : AN_RF_007
		<b>Beanair Wireless sensor networks  deployment guideline</b>	

transmitting antenna has a dominant polarization which, by convention, is defined as horizontal or vertical. The range of the broadcast is optimised by using a receiving antenna with the same polarisation, particularly when there is a line-of-sight or directional antennae are used. The use of cross-polarised antennae will result in reduced range. Normally, an antenna will have guidelines and/ or markings that show the dominant polarisation. Where there is no line-of-sight, polarisation becomes less important, as signals reflected from different objects arrive with widely differing polarisations (multipath propagation is described in [Chapter 10](#)).

## 9.5 ANTENNA COMMISSIONING

If we now look at the concept of directivity in terms of commissioning a wireless network, there are two scenarios to consider:

- **Non-engineered:** A node is installed in a changing network in which the node is required to communicate with other nodes in various directions. These directions may be known or unknown, but they may also change with time as nodes are added or moved. This scenario requires that all directions are covered by the antenna's radiation pattern and, therefore, the use of an antenna with low directivity, such as the half-wave dipole shown in [Figure 5](#).
- **Engineered:** A node is installed in a fixed network to communicate with one or a number of fixed nodes. This situation can benefit from using a directive antenna, if the antenna can be oriented correctly during installation. However, subject to a lower range performance, this type of network can still use a nondirective antenna.



*Beanair recommends the use of half-wavelength dipoles which, at 2.45 GHz, are relatively small antennae but effective performers.*

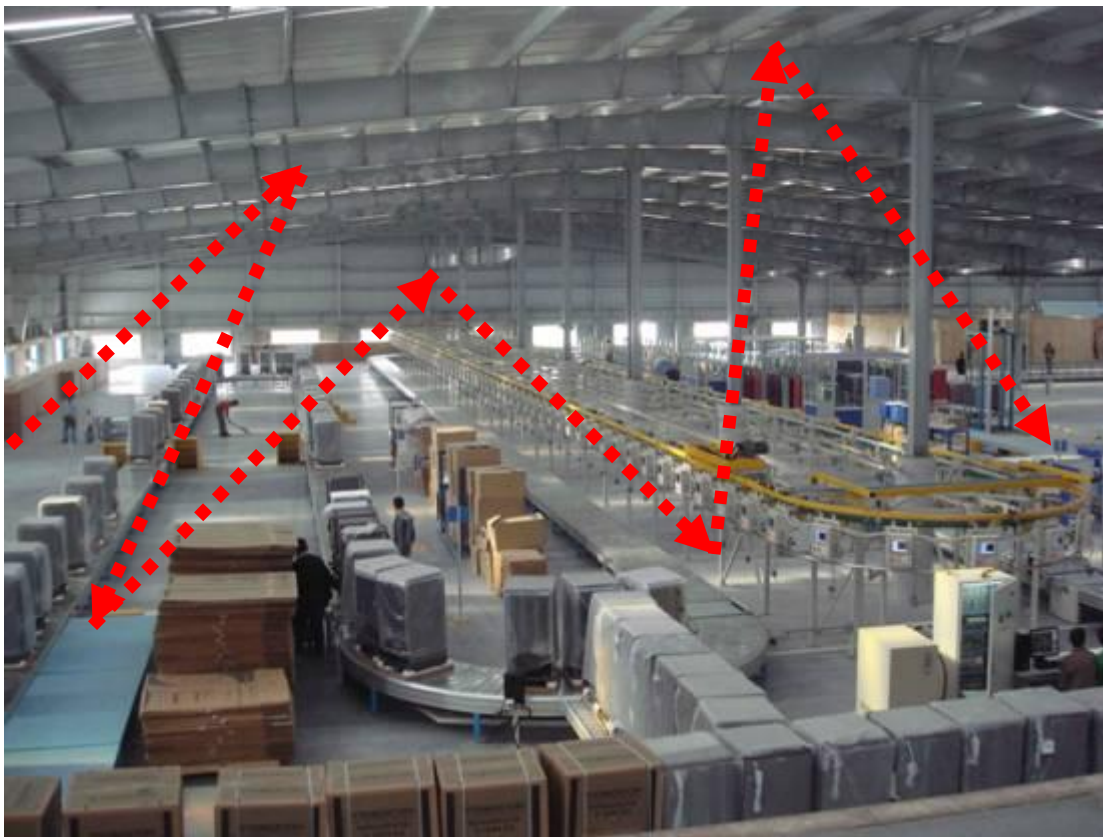


*Beandevic<sup>®</sup> Ecosensor products are not adapted for long range applications. We recommend to use BeanDevice ProcesSensor or SmartSensor products.*

Ref: Application note NA_007	Publication date : 07/08/2010		Page : 25 / 36
---------------------------------	-------------------------------	--	----------------


## 10. REFLECTIONS, OBSTRUCTIONS AND MULTIPATH

In a free-space situation with no nearby obstructions, radio waves have a clear path between two wireless network devices. In reality, this situation is only approximately possible when nodes are very close together, perhaps several meters, and there are no other structures nearby. More often, there are obstructions in the direct line-of-sight as well as structures around the devices giving rise to absorption of radio energy and multiple reflections. This situation is illustrated in [Figure 7](#) below:



**Figure 7: A Simple Multipath Situation in a factory**

This situation is extremely complex and varies with the type of installation. In fact, radio waves will propagate through brick walls, concrete floors and plasterboard partitions, among other materials, but a loss will be incurred (as compared with freespace propagation). Depending on the thickness, moisture content and angle of incidence, a wall may allow between 1/100 and 1/4 of the radio power to pass through. In radio terms, this loss is significant but not a disaster. However, a metal panel or metallised glass window will not allow much radio power to pass through - the vast majority of the incident power will be reflected, as if the panel were a mirror (beware that plasterboard is often backed with metal foil). This can be a serious issue since losses can build up very quickly. However, some radio power may propagate through small holes (apertures) in the panel or around metal edges through the process of diffraction.

	<b>BeanAir</b> 1, mail Gay Lussac 95000 Neuville-Sur-Oise France	Draft Version : V1R0	Draft Reference : AN_RF_007
		<b>Beanair Wireless sensor networks  deployment guideline</b>	

Thick layers of building material absorb a lot of radio energy - for example, very thick stone walls. Such absorption also poses problems for overground-to-underground communication.

For particularly difficult environments, it may be advisable to request advice on antenna types and placement from Beanair Support or external specialists.

An IEEE 802.15.4 wireless network will not work underwater. In addition, nodes operating in wet conditions (i.e. in heavy rainfall) may exhibit some degradation. In most cases, water droplets on or close to the antenna are more serious than the rain itself, so care should be taken to ensure that enclosures shed water well.

Apart from a few situations, it is very difficult to exclude ALL radio power from an area.

Thus, a radio link can be made to work under most situations with some careful planning, but there are many situations to consider and radio path losses vary widely.


**For example:**

- A large public building may have few obstructions between nodes, but large amounts of metallic panelling that cause reflections.
- A small domestic installation may have numerous brick walls between nodes in individual rooms.
- An office building may have metallised dry-wall partitions together with mezzanine ceilings.
- A system in an open-air car park will enjoy relatively few obstructions and may benefit from elevated gantry sites.

Given the huge variation in situations, many researchers have studied the effects of the environment on 2.4-GHz radio wave propagation. The techniques used have varied from deterministic models using ray-tracing techniques to statistical approaches using curve fitting to measured data. These are used to determine the siting of individual radio devices.

The BeanScape<sup>®</sup>, our wireless sensor networks supervision software, incorporates a wireless diagnostic tool used to perform radio link measurements (PER estimation, Link Quality Indicator) specific to the installation before individual nodes are placed in their final positions. This technique has been used widely for wireless PBX equipment (cordless telephones) and professional proprietary radio systems. It is assumed that a typical installation of a wireless network is unlikely to have the benefit of a detailed site survey or propagation modelling techniques. The placing of individual nodes will be largely non-engineered, as they will normally be sensors or switches with positions determined by other factors.

Ref: Application note NA_007	Publication date : 07/08/2010		Page : 27 / 36
---------------------------------	-------------------------------	--	----------------

	<b>BeanAir</b> 1, mail Gay Lussac 95000 Neuville-Sur-Oise France	Draft Version : V1R0	Draft Reference : AN_RF_007
		<b>Beanair Wireless sensor networks deployment guideline</b>	

## 11. DEPLOYMENT GUIDELINES

The following sections offer some guidelines as a starting point for planning purposes.

### 11.1 GENERAL GUIDELINES

One of the most important factors when placing any node is its height above its immediate environment. As a general rule in buildings, head height or above is preferred, and the higher the better for maximizing range. If nodes must be placed in positions very close to the floor, such as a radiator thermostat, then the range may be reduced by between 50% and 90%.

It is also important to consider the environment close to the antenna. If possible, avoid placing the node where there are obscuring objects (such as metal pillars, posts or signs) near to the antenna - a close object obscures a wider range of solid angle.

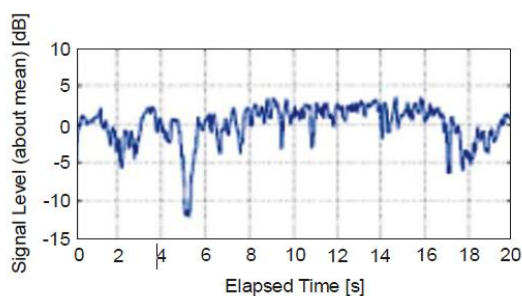
### 11.2 MULTIPATH AND FADE MARGINS

It is a fact of life that radio reflections will be present in most 2.4-GHz radio paths.

When the path between two radio antennae is assessed, the transmitted signal can follow many different paths to arrive at the receive antenna. One path may be direct, but other paths may involve multiple reflections from walls or metal obstructions.


These are "multiple paths", normally shortened to "multipath". This is a common experience in analogue TV systems, where it can cause a "ghost" on a television image. Where there is no line-of-sight, it is multipath (i.e. the scattered signal) that propagates the radio energy, and here multipath therefore provides a useful service.

However, multipath gives rise to power fluctuations about an average value depending on location and, in a busy area, time. This is illustrated in [Figure 8](#) below, which shows the variation in signal strength over time in a laboratory environment with people moving around. In basic terms, the strong signals regions (or peaks) are present when the multipath signals arrive in phase and add up - this is known as constructive interference. In the low signal regions (nulls), the multipath signals arrive out of phase and cancel each other out - this is known as destructive interference.



**Figure 8: Multipath Fading Over Time**

Ref: Application note NA_007	Publication date : 07/08/2010		Page : 28 / 36
---------------------------------	-------------------------------	--	----------------

	<b>BeanAir</b> 1, mail Gay Lussac 95000 Neuville-Sur-Oise France	Draft Version : V1R0	Draft Reference : AN_RF_007
		<b>Beanair Wireless sensor networks  deployment guideline</b>	

Depending on the strength of the direct signal compared with the reflected signal, this variation can be serious. In a non-LOS situation at 2.45 GHz, it is possible to move the receive antenna only 3 to 4 cm and see signal levels vary from 6 dB to -20 dB when compared with the local average. This can be characterised by using a statistical multipath model, although this is rarely used in practical situations. Instead, a "fade margin" can be applied. This works by ensuring that the average signal level is well above the sensitivity of the system, allowing a "margin" of error when "fades" occur.

The required size of this margin depends on the desired level of confidence. In a mesh network, it can be argued that when many alternative routes are available, moderate confidence (perhaps 50% of locations are above a certain power level) is acceptable.

When the network is more sparse, the confidence level should be increased (perhaps to 75% or even 90%). A word of caution here - a law of diminishing returns applies to confidence levels - with any wireless system, to achieve a confidence level of 99.9% would probably require extremely low node spacing.



*As a typical guide, when nodes are installed, there should be about 20 dB path loss margin allowed to take fades into account and to give an acceptable level of confidence.*

### 11.3 OPEN SPACE GUIDELINES

---

For an open space, a typical installation would be the provision of nodes along a perimeter fence or across a car park. In radio propagation terms, these situations are line-of-sight with little or no obstructions, and therefore do not suffer largely from multipath effects. In these situations, it is acceptable to neglect the traditional fade margin.

Using a free-space approximation is a good starting point for such situations - a range of 1-2 km should be achievable, if each node is 2 meters or higher above the local ground. A high-power module will achieve a much larger range, but when ranges are above approximately 500 meters a point-to-point link approximation must be used.



*Another word of caution here - the height at which a node is installed is crucial to using free-space rules. In short, if the free-space approximation is applied, the nodes at transmit and receive ends must be elevated above local obstructions. This is especially important as the required range increases.*

### 11.4 INDOOR ENVIRONMENT GUIDELINES

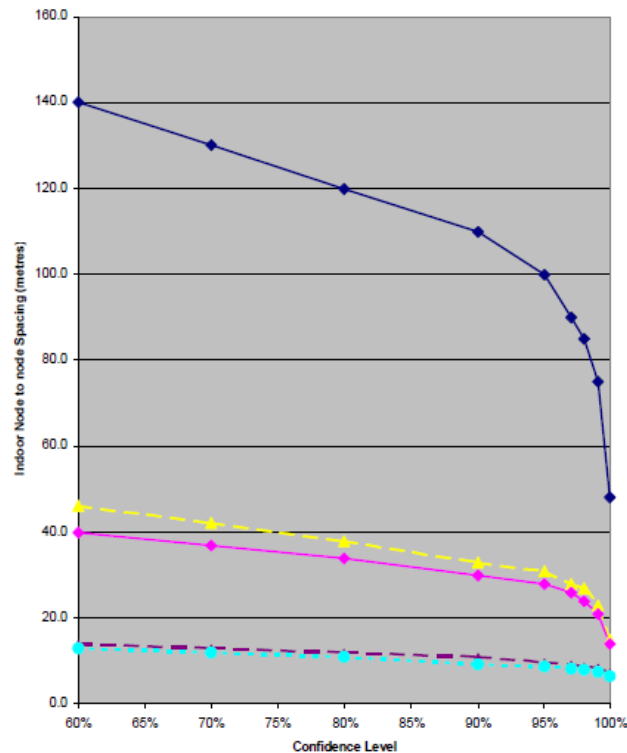
---

Following on from [Chapter 10](#), it is certain that when a link is set up inside a building it will exhibit a shorter range than suggested by the free-space guidelines, even when a line-of-sight is present. In cluttered environments, the range reduction can be very significant.

There are many different types of environment for any model that is created to cover indoor radio propagation. However, this document has used a generalised and modified version of the models. For a


Ref: Application note NA_007	Publication date : 07/08/2010		Page : 29 / 36
---------------------------------	-------------------------------	--	----------------

guide to node spacings at different levels of confidence, refer to the publication "*The Mobile Radio Propagation Channel*" by David Parsons (Pentech Press 1992, ISBN0-7273-1316-9). **Figure 9** plots node-to-node spacing versus confidence level for situations where there is no directional antenna and no line-of-sight present. The plot uses typical values for the Beandevise AX-3D (Wireless accelerometer). Furthermore, in **Figure 9** scenarios are considered for traversing zero, one and two floors. The node-to-node spacings displayed in **Figure 9** are very approximate. However, they do provide some guidelines for pre-planning an installation, if time permits. If this is not feasible, a simple approach of pacing out distances between nodes will bring rewards in terms of mesh reliability (for information on mesh networks, refer to **Chapter 7**).



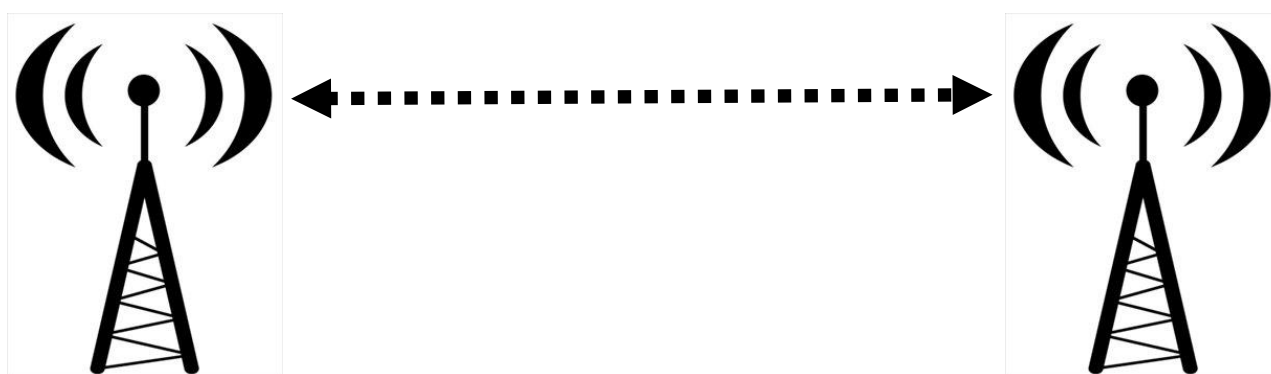
◆ High Power Module Traversing 0 Floors     ▲ High Power Module Traversing 1 Floors  
◆ Low Power Module Traversing 0 Floors     ▲ High Power Module Traversing 2 Floors  
● Low Power Module Traversing 1 Floors

**Figure 9: Node-to-Node Spacing for Various Modules and Confidence Levels**

	<b>BeanAir</b> 1, mail Gay Lussac 95000 Neuville-Sur-Oise France	Draft Version : V1R0	Draft Reference : AN_RF_007
		<b>Beanair Wireless sensor networks deployment guideline</b>	

## 12.POINT-TO-POINT LINK GUIDELINES

A point-to-point (or fixed) link is, by definition, an engineered radio link. It is designed to link two specific points and is always raised above or placed away from local obstructions. Examples in everyday use include a DBS satellite dish - in this case, the dish antenna is carefully aligned with a geostationary satellite found at a specific bearing.




*Figure 9: Point to point Link*

In a wireless network, it is reasonable to assume that the two radio nodes of a point-to-point link will be elevated on a roof or, perhaps, high up on a wall. The nodes will also have directional antennae with a line-of-sight between them, even though they may be separated by several kilometers. In this situation, the main concerns will be any buildings or other large obstructions in the path between the directional antennae, and the height of the antennae above the ground. Fixed-link planners spend a lot of time working through these considerations. However, for links that have a range of less than approximately 10km, it is possible to obtain some guidance from what is called the "plane-earth propagation" model, with Egli's empirical terrain factor – refer to *"The Mobile Radio Propagation Channel"* by David Parsons (Pentech Press 1992, ISBN0-7273-1316-9). The assumption here is that the height of the antennae (while above local obstructions) is much less than the distance between the antennae.



*To achieve optimum range between two nodes in a wireless network, the nodes should be located as high as possible off the ground/floor.*

Ref: Application note NA_007	Publication date : 07/08/2010		Page : 31 / 36
---------------------------------	-------------------------------	--	----------------

	<b>BeanAir</b> 1, mail Gay Lussac 95000 Neuville-Sur-Oise France	Draft Version : V1R0	Draft Reference : AN_RF_007
		<b>Beanair Wireless sensor networks  deployment guideline</b>	

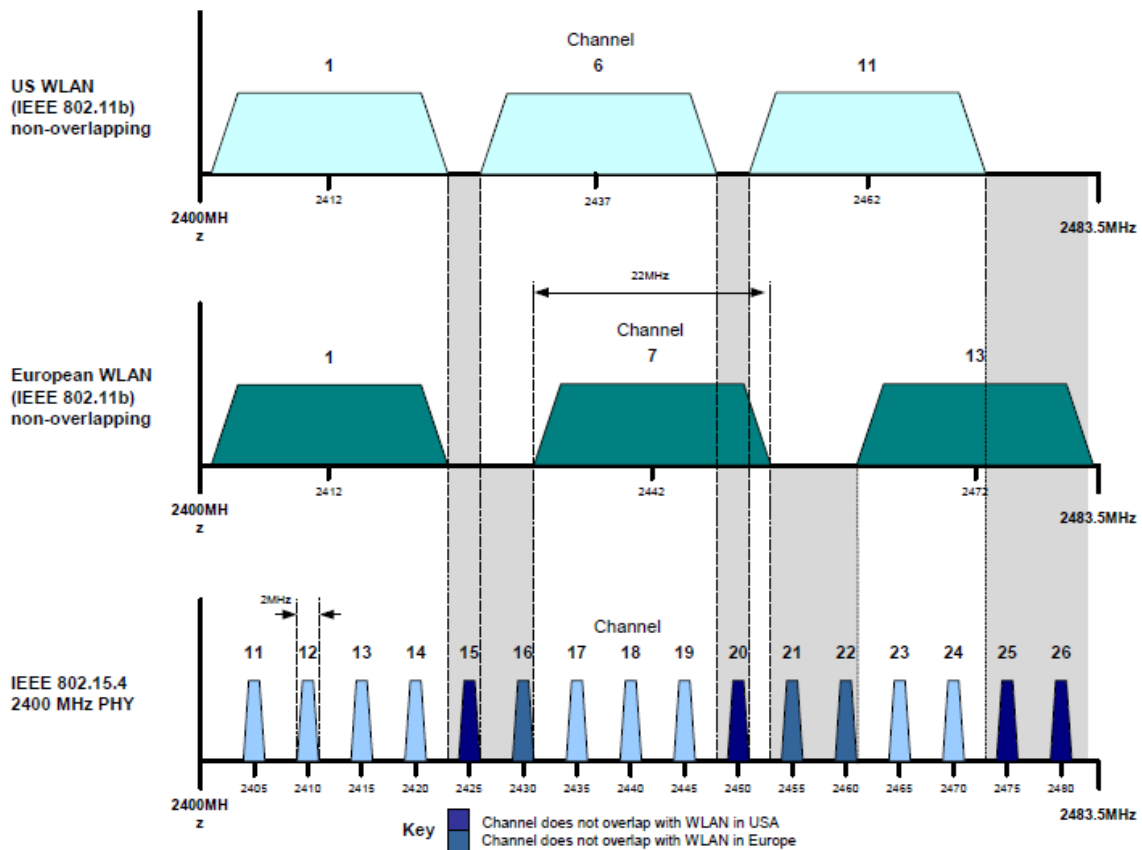


*High gain antennae may not be permitted under some local radio regulations and guidance should be sought before using them with ISM band equipment.*

Ref: Application note NA_007	Publication date : 07/08/2010		Page : 32 / 36
---------------------------------	-------------------------------	--	----------------

### 13.SHARING CHANNELS WITH OTHER RADIO SYSTEMS

As mentioned earlier, the ISM band at 2.4 GHz is used by a variety of radio system types. To illustrate this issue, [Figure 12](#) below shows the situation with respect to the now prevalent WLAN (Wireless Local Area Network) systems.




**Figure 12: ISM Band Sharing**

Any fixed channel system, such as WLAN, that uses the same radio channel as an IEEE 802.15.4 network can seriously disrupt the network when handling large amounts of data. However, in most applications, it is possible to arrange that the WLAN and IEEE 802.15.4 systems use different channels. As can be seen in [Figure 12](#), it is usually possible to find channels that are not used by WLAN systems.

To avoid interference, the channel scanning algorithm in IEEE 802.15.4 can be used to ensure that the best channel is chosen.

Another widely used system that shares the ISM band at 2.4 GHz is Bluetooth. Used mainly for headsets and some peripheral connections, the Bluetooth system rapidly hops across most of the 2.4 GHz band. This may disrupt an IEEE 802.15.4 Network, but degradation in performance would be gradual.

	<b>BeanAir</b> 1, mail Gay Lussac 95000 Neuville-Sur-Oise France	Draft Version : V1R0	Draft Reference : AN_RF_007
		<b>Beanair Wireless sensor networks  deployment guideline</b>	

Microwave ovens are present in many IEEE 802.15.4 operating areas and do exhibit low levels of leakage that can disrupt IEEE 802.15.4 (or any ISM 2.4 GHz) equipment. However, the duty cycle of microwave cavity ovens is such that there is plenty of time between cooking cycles for IEEE 802.15.4 packets to be transmitted successfully.

As a general rule, for any installation, it is always worth assessing the other systems that may be installed nearby. When transmitter and receiver are close together, they couple energy very well indeed. The same rule also applies to any interfering systems.

Therefore, if the situation allows, it is worth locating nodes as far away as possible from items such as Wi-Fi routers and microwave ovens. A distance of several meters may suffice, but ten meters is preferable.

Note that international radio regulations which govern radio equipment ensure that cellphones use their allocated bands only. It is therefore highly unlikely that cellphones will interfere with IEEE 802.15.4 equipment.



*The BeanScape software integrates a wireless sensor networks diagnostic tool, allowing the user to track in real-time the PER (Packet Error Rate) and LQI (Link Quality Indicator) on each wireless sensor.*



*For further information, don't hesitate to read our Technical Note on Wifi/IEEE 802.15.4 Cohabitation.*

Ref: Application note NA_007	Publication date : 07/08/2010		Page : 34 / 36
---------------------------------	-------------------------------	--	----------------




**BeanAir**  
1, mail Gay Lussac  
95000 Neuville-Sur-Oise  
France

Draft Version : V1R0

Draft Reference :  
AN\_RF\_007

**Beanair Wireless sensor networks  
deployment guideline**

	<b>BeanAir</b> 1, mail Gay Lussac 95000 Neuville-Sur-Oise France	Draft Version : V1R0	Draft Reference : AN_RF_007
		<b>Beanair Wireless sensor networks  deployment guideline</b>	

## 14. DEPLOYMENT CHECKLIST

The following checklist provides a summary of factors from an RF view-point that you need to consider when designing/installing a wireless network.

■ **Choose an antenna type which is appropriate for your network:**

- If a node needs to receive and transmit signals in various directions, use an antenna with low directivity - Beanair recommends a half-wave dipole antenna.
- If a node needs to receive and transmits signals only in a specific direction, use an antenna with high directivity, such as a Yagi antenna - this solution is suitable for point-to-point links which require a large range.

Refer to [Section 9.2](#) for details.

- Ensure that the gains, transmit power and receive sensitivity of your chosen antennae are sufficient to achieve the required range - refer to [Section 9.3](#).
- Be sure to orientate the antennae such that their dominant polarisations are aligned (particularly for point-to-point links) - see [Section 9.4](#).
- Where possible, try to ensure an uninterrupted line-of-sight between nodes – be aware that the following will reduce signal strength and quality:
  - Obstructions (such as furniture and people) absorb, reflect and diffract radio waves.
  - Walls, floors and ceilings absorb and reflect radio waves - the degree of absorption depends on the thickness, structure and construction materials.

Refer to [Chapter 10](#) for details.

- If there is no line-of-sight between nodes, be aware that multipath radio propagation (through reflection and diffraction) is vital to achieve radio communication - you may be able to help produce a good multipath signal by positioning nodes such that their signals reflect off a plane surface.
- When siting nodes, the following factors are useful to bear in mind:
  - It is normally beneficial to place nodes as high as possible (unless there are obstructions to be avoided, such as support beams and ceiling lights).
  - If obstructions are unavoidable, do not place a node near to an obscuring object, since a close object obscures a larger solid angle.
  - You can check the quality of radio communications in an installed network using the Network diagnostic feature provided by the BeanScope® ( read the Beanscape User Manual for further informations).
  - Wireless networks based on IEEE 802.15.4 can automatically select the frequency channel with least detected activity when sampled at system start-up. If you wish to use a pre-configured channel, you should first investigate the potential interference present in the given operating environment using the Energy Scan feature provided by the BeanScope® ( read the Beanscape User Manual for further informations).

Ref: Application note NA_007	Publication date : 07/08/2010		Page : 36 / 36
---------------------------------	-------------------------------	--	----------------