



TECHNICAL NOTE

Co-existence of Beanair[®] wireless sensor network at 2.4 GHz

	BeanAir "Plug and Play" Wireless Sensor Network	Version : V1.0
	Cergy Pontoise	Wireless range benchmarking on BeanDevice®

DOCUMENT			
Document number		Version	V1.0
External Reference	RF_NT_0011 V1.0	Publication date	01/12/2011
Author	Jules SACHOT		
Internal Reference		Project Code	N.A.
Document Name	<i>Co-existence of Beanair®'s products with other wireless networks</i>		

VALIDATION			
Function	Recipients	For Validation	For information
Reader	Damon PARSY		X
Author	Jules SACHOT	X	

MAILING LIST			
Function	Recipients	For action	For Info
Staffer 1	Jules SACHOT	X	
Staffer 2	Christophe DONTEGREUIL		X

Updates			
Version	Date	Author	Evolution & Status
V1.0	01/12/2011	Jules SACHOT	First version of the document

	BeanAir “Plug and Play” Wireless Sensor Network	Version : V1.0
	Cergy Pontoise	Wireless range benchmarking on BeanDevice®

Contents

1.	TECHNICAL SUPPORT	4
2.	VISUAL SYMBOLS DEFINITION	5
3.	ACRONYMS AND ABBREVIATIONS.....	6
4.	AIM OF THE DOCUMENT.....	7
5.	PRESENTATION OF THE 2.4 GHZ BANDWITH'S SIGNALS.....	8
5.1	What is the IEEE 802.15.4 ?	8
5.2	Spectrum Sharing in 2.4-GHz ISM Band	8
5.3	IEEE 802.15.4 LR-WPAN.....	8
5.4	IEEE 802.11 b/g - WIFI	9
5.5	Bluetooth	10
5.6	Microwave Ovens.....	11
5.7	Channel Allocation	11
6.	OVERVIEW OF THE IEEE 802.15.4 STANDARD.....	13
6.1	DSSS Transmission	13
6.2	PROTOCOL	14
6.2.1	Dynamic Channel Selection	14
6.2.2	CSMA-CA	14
6.2.3	Acknowledged Transmission and Retries	14
6.2.4	Data rate	14
7.	PRESENTATION OF THE TESTS.....	15
7.1	BeanDevice® antenna specification	15
7.2	BeanGateway® antenna CHARACTERISTICS	16
8.	GLOBAL INSTALLATION.....	17
9.	REACTION WITH ADJACENT CHANNELS (ON SHORT DURATION).....	18
9.1	Distance between the BeanDevice® and the BeanGateway® = 1 meter.....	18
9.2	Distance between the BeanDevice® and the BeanGateway® = 5 meters	19
9.3	Distance between the BeanDevice® and the BeanGateway® = 12 meters	20
10.	SYSTEM BEHAVIOUR WITH ADJACENT CHANNELS (ON LONG DURATION).....	21
11.	CONCLUSION OF THE TESTS.....	23

	BeanAir “Plug and Play” Wireless Sensor Network	Version : V1.0
	Cergy Pontoise	Wireless range benchmarking on BeanDevice®

Disclaimer

- The information contained in this document is the proprietary information of BeanAir.
- The contents are confidential and any disclosure to persons other than the officers, employees, agents or subcontractors of the owner or licensee of this document, without the prior written consent of BeanAir Ltd, is strictly prohibited.
- BeanAir makes every effort to ensure the quality of the information it makes available. Notwithstanding the foregoing, BeanAir does not make any warranty as to the information contained herein, and does not accept any liability for any injury, loss or damage of any kind incurred by use of or reliance upon the information.
- BeanAir disclaims any and all responsibility for the application of the devices characterized in this document, and notes that the application of the device must comply with the safety standards of the applicable country, and where applicable, with the relevant wiring rules.
- BeanAir reserves the right to make modifications, additions and deletions to this document due to typographical errors, inaccurate information, or improvements to programs and/or equipment at any time and without notice.
- Such changes will, nevertheless be incorporated into new editions of this document.

Copyright: Transmittal, reproduction, dissemination and/or editing of this document as well as utilization of its contents and communication thereof to others without express authorization are prohibited. Offenders will be held liable for payment of damages. All rights are reserved.

Copyright © BeanAir Ltd. 2010.

	BeanAir “Plug and Play” Wireless Sensor Network	Version : V1.0
	Cergy Pontoise	Wireless range benchmarking on BeanDevice®

1. TECHNICAL SUPPORT

For general contact, technical support, to report documentation errors and to order manuals, contact **BEANAIR® Technical Support Center** (BTSC) at:

tech-support@beanair.com

For detailed information about where you can buy the BeanAir equipment/software or for recommendations on accessories and components visit:



www.beanair.com

To register for product news and announcements or for product questions contact BEANAIR®'s Technical Support Center (BTSC).

Our aim is to make this user manual as helpful as possible. Please keep us informed of your comments and suggestions for improvements. BeanAir appreciates feedback from the users.

	BeanAir "Plug and Play" Wireless Sensor Network	Version : V1.0
	Cergy Pontoise	Wireless range benchmarking on BeanDevice®

2. VISUAL SYMBOLS DEFINITION

<i>Visual</i>	<i>Definition</i>
	<p><u>Caution or Warning</u> – Alerts the user with important information about BeanAir wireless sensor networks (WSN), if this information is not followed, the equipment /software may fail or malfunction.</p>
	<p><u>Danger</u> – This information MUST be followed if not you may damage the equipment permanently or bodily injury may occur.</p>
	<p><u>Tip or Information</u> – Provides advice and suggestions that may be useful when installing BeanAir Wireless Sensor Networks.</p>

	BeanAir “Plug and Play” Wireless Sensor Network	Version : V1.0
	Cergy Pontoise	Wireless range benchmarking on BeanDevice®

3. ACRONYMS AND ABBREVIATIONS

LQI	Link quality indicator
PER	Packet error rate
WLAN	A wireless local area network links two or more devices over a short distance using a wireless distribution method.
LOS	Line-of-sight
Mb	Mega-Bytes
Mbps	Mega-Bytes per second
RF	Radio Frequency
FTP	File Transfer Protocol is a standard network protocol used to transfer files from one host to another host over a TCP-based network.
TCP	The Transmission Control Protocol is one of the core protocols of the Internet Protocol Suite.
m	Meter(s)

	BeanAir “Plug and Play” Wireless Sensor Network	Version : V1.0
	Cergy Pontoise	Wireless range benchmarking on BeanDevice®

4. AIM OF THE DOCUMENT

This document aims to highlight the issues affecting co-existence of Beanair WSN (IEEE 802.15.4) in the presence of interference. The measures employed by the 802.15.4 standard to ensure reliable co-existence are outlined. The practical performance of IEEE 802.15.4 systems are established with reference to supporting empirical data. Finally, guidelines are provided for installing sensor networks in either a planned or unplanned RF environment.

This document is not intended to show precisely the behavior of our BeanDevices® in WIFI environments, but gives an idea of the results you could have in your future installation.

Please note that these computed values can change, depending strongly on your environment.

By the way, you will find information about interferences on other BeanAir documents.

	BeanAir “Plug and Play” Wireless Sensor Network	Version : V1.0
	Cergy Pontoise	Wireless range benchmarking on BeanDevice®

5. PRESENTATION OF THE 2.4 GHZ BANDWITH'S SIGNALS

5.1 WHAT IS THE IEEE 802.15.4 ?

- IEEE 802.15.4 is a Low-Rate Wireless Personal Area Network (LR-WPAN) standard aimed at providing simple, low-cost communication networks.
- LR-WPANs are intended for short-range operation and involve little or no infrastructure.
- The standard focuses on applications with limited power and relaxed throughput requirements, with the main objectives being ease of installation, reliable data transfer, low-cost and low-power.
- This allows small, power-efficient, inexpensive solutions to be implemented for a wide range of devices.

5.2 SPECTRUM SHARING IN 2.4-GHZ ISM BAND

The unlicensed 2.4-GHz ISM band is used by a variety of devices, standards and applications. In order to focus on the co-existence issues relating to the operation of LR-WPANs, only the most common systems operating in the 2.4-GHz ISM band are considered here.

5.3 IEEE 802.15.4 LR-WPAN

- The IEEE 802.15.4 standard is intended to conform to established regulations in Europe, Japan, Canada and the United States, and defines two physical (PHY) layers - the 2.4-GHz and 868/915-MHz band PHY layers.
- A total of 16 channels are available in the 2.4-GHz band, numbered 11 to 26, each with a bandwidth of 2 MHz and a channel separation of 5 MHz.
- LR-WPAN output powers are around 0 dBm and typically operate within a 50-m range.

PHY (MHz)	Frequency Band (MHz)	Geographical Region	Modulation	Channels	Bit Rate (kbps)	Typical Output Power (dBm)
868/915	868-868.6	Europe	BPSK	1	20	0
	902-928	United States	BPSK	10	40	0
2450	2400-2483.5	Worldwide	O-QPSK	16	250	0

5.4 IEEE 802.11 B/G - WIFI

The IEEE 802.11b and 802.11g Wireless LAN (WLAN) standards operate in a total of 14 channels available in the 2.4-GHz band, numbered 1 to 14, each with a bandwidth of 22 MHz and a channel separation of 5 MHz. This channel mapping can be seen in the channel frequency table of Appendix D. WLAN output powers are typically around 20 dBm and operate within a 100-m range.

The transmit scheme used by 802.11b is DSSS. Although 802.11g is backwards compatible with 802.11b, the 802.11g standard achieves higher data rates by implementing an additional OFDM transmission scheme. This leads to fundamentally different spectral masks, as seen in Figure 1 and Figure 2.

The IEEE 802.11 physical layer also includes multi-rate support. If the current data rate cannot be sustained due to interference or low received signal strength, dynamic data rate switching is applied to choose a more appropriate data rate (and modulation technique).

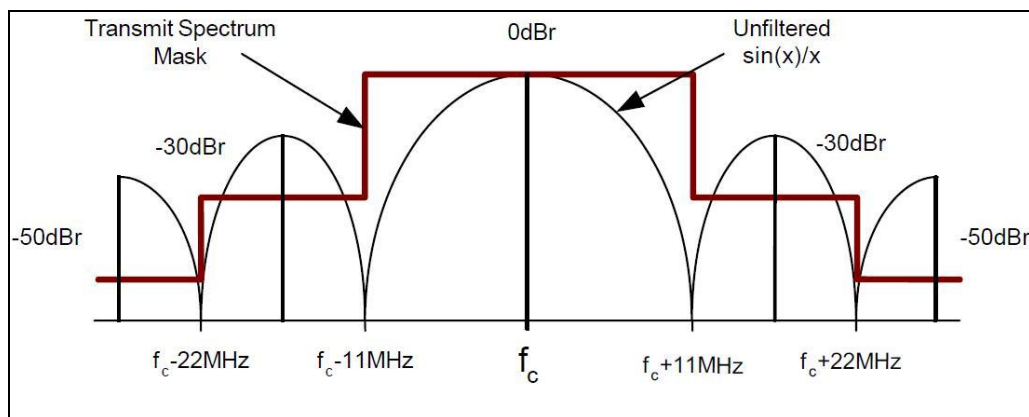

IEEE 802.11b Spectral Mask

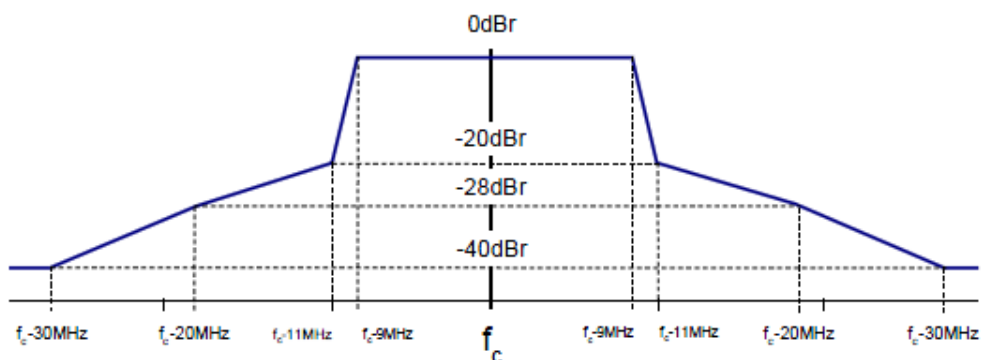

IEEE 802.11g Spectral Mask

	BeanAir "Plug and Play" Wireless Sensor Network	Version : V1.0 Wireless range benchmarking on BeanDevice®
	Cergy Pontoise	

PHY (MHz)	Frequency Band (MHz)	Geographical Region	Modulation	Channels	Bit rate (Mbps)	Typical Output Power (dBm)
2450	2401-2483	Europe* Japan	DBPSK DQPSK	13	1, 2, 5.5, 11	20
	2401-2473	United States, Canada		11		
	2446-2483	France		4		
	2446-2473	Spain		2		

* Excluding France and Spain

IEEE 802.11b Frequency Bands and Data Rates

PHY (MHz)	Frequency Band (MHz)	Geographical Region	Modulation	Channels	Bit rate (Mbps)	Typical Output Power (dBm)
2450	2401-2483	Europe* Japan	DBPSK DQPSK QAM-16 QAM-64	13	1, 2, 5.5, 11, 6, 9, 12, 18, 24, 36, 48, 54	20
	2401-2473	United States Canada		11		
	2446-2483	France		4		
	2446-2473	Spain		2		

* Excluding France and Spain

IEEE 802.11g Frequency Bands and Data Rates

5.5 BLUETOOTH

The IEEE 802.15.1 Bluetooth standard operates in 79 channels available worldwide in the 2.4-GHz band. Numbered 0 to 78, each channel has a bandwidth of 1 MHz and a channel separation of 1 MHz. Channel centre frequencies are defined by the formula:

$$f = 2402 + k \text{ (MHz)}, \quad k = 0...78$$

Bluetooth output powers are generally less than 4 dBm for the more commonly used class 2 devices such as wireless headsets and keyboards. Ranges of around 10 m are typical. The less common class 1 devices can operate at up to 20 dBm and typically within a 100-m range. Although not mandatory for class 2 devices, almost all Bluetooth devices implement power control in order to reduce power consumption. Therefore, the output power is often less than 4 dBm and can be as low as -30 dBm for Bluetooth devices in close proximity. Data rates of 1 Mbps are achieved in version 1.2 of the standard [6] and 3 Mbps in version 2.0 + EDR (Enhanced Data Rate).

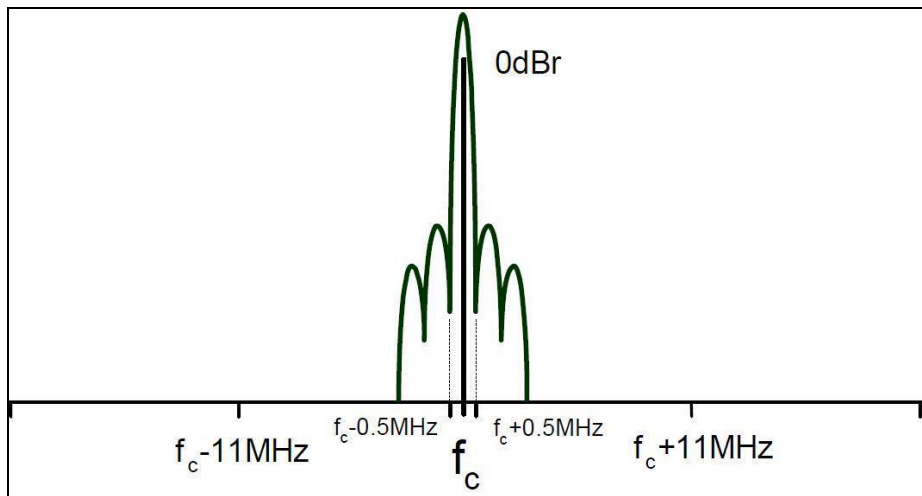

Figure: Bluetooth spectral Mask

The transmission scheme used in Bluetooth is fundamentally different from that used in WLAN and LR-WPAN systems. These networks use DSSS to spread energy across a relatively wide signal bandwidth while Bluetooth uses FHSS to transmit a narrow band signal (Figure: Bluetooth Spectral Mask). In the latter scheme, the signal power is spread across the entire band by constantly changing the transmit channel frequently in a pre-determined pattern. The Bluetooth ‘Hop Rate’ is 1600 hops/s (625µs between hops).

5.6 MICROWAVE OVENS

Microwave ovens operate at around 2.45 GHz. Although they should be covered by a Faraday cage, it is still possible for some leakage to occur around the doors. This is increased when mechanical abuse or simple ‘wear and tear’ causes door seals to become less effective. For these reasons, microwave ovens are a potential source of interference for IEEE 802.15.4 Network, but the reality is that microwave ovens cause very little interference.

5.7 CHANNEL ALLOCATION

For IEEE 802.15.4 and Bluetooth, the allocated channel usage is accepted worldwide. For WLAN, however, channel usage depends on the regulatory domain (see WLchannel frequency listings in Appendix D). In the US and Canada for example, channels 13 and 14 are not used. This allows two LR-WPAN channels to operate clear of Wi-Fi interference. In addition, the 802.11b standard [3] recommends the use of non-overlapping operating channels - 1, 6 and 11 for North America, and 13 for Europe. Although this operating practice is not mandatory, it is often employed where multiple access points are in use. This allows further clear channels for operation of IEEE 802.15.4 Network as shown in figure below

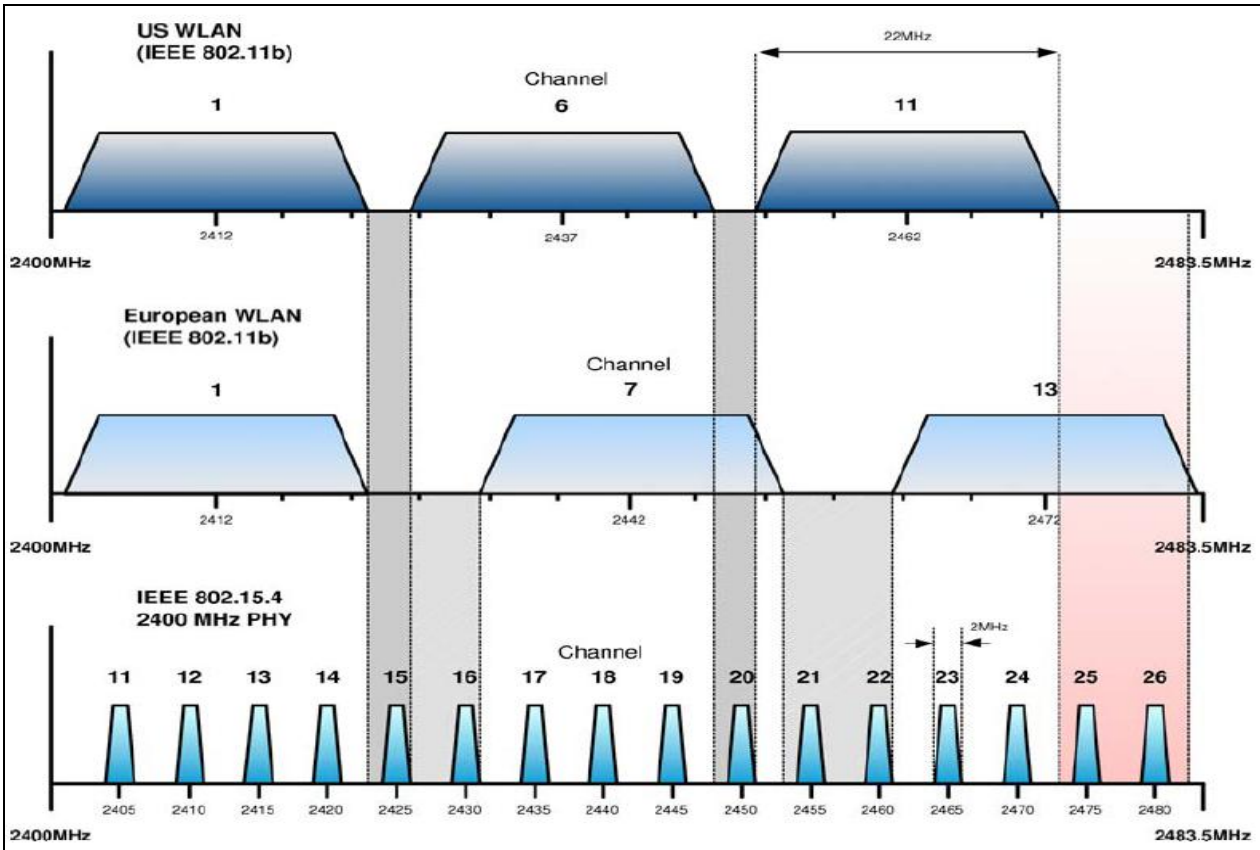

Figure 3: IEEE 802.15.4 versus Non-Overlapping WLAN Channel Allocations

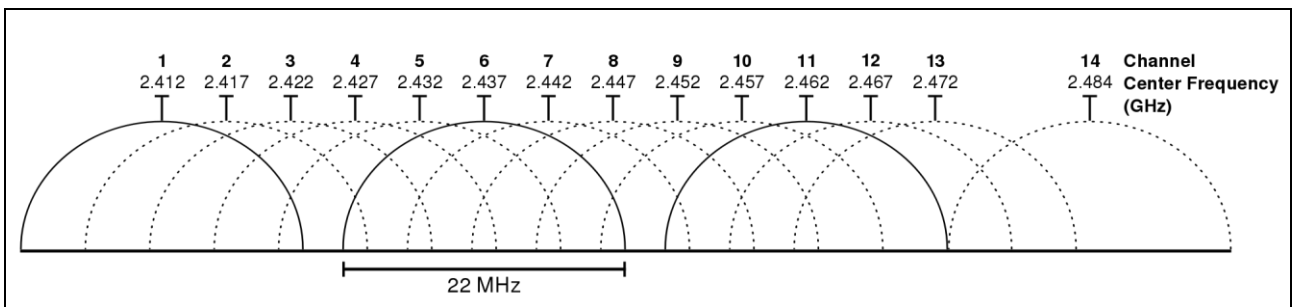

Figure 4: The 14 different WIFI channels

6. OVERVIEW OF THE IEEE 802.15.4 STANDARD

Standards such as IEEE 802.15.4 are designed to ensure reliable co-existence and provide several mechanisms that enhance co-existence with other wireless devices operating in the 2.4-GHz band.

6.1 DSSS TRANSMISSION

The Direct Sequence Spread Spectrum (DSSS) transmit scheme used in 802.15.4 is designed to promote co-existence. The basic idea is to use more bandwidth than is strictly required, thus *spreading* the signal over a wider frequency band. This is achieved by mapping the incoming bit-pattern into a higher data-rate bit sequence using a “chipping” code (effectively adding redundancy). Since the signal is spread over a larger bandwidth, narrow-band interferers block a smaller overall percentage of the signal, allowing the receiver to recover the signal.

The BER to SNR for IEEE 802.15.4 is shown in the following graph, along with Wi-Fi and Bluetooth. It can be seen that the performance of the 802.15.4 transmission is between 7 and 18 dB better than that of 802.11b and Bluetooth. This can be directly translated to a range increase from 2 to 8 times the distance for the same energy per bit, or an exponential increase in reliability at any given range .

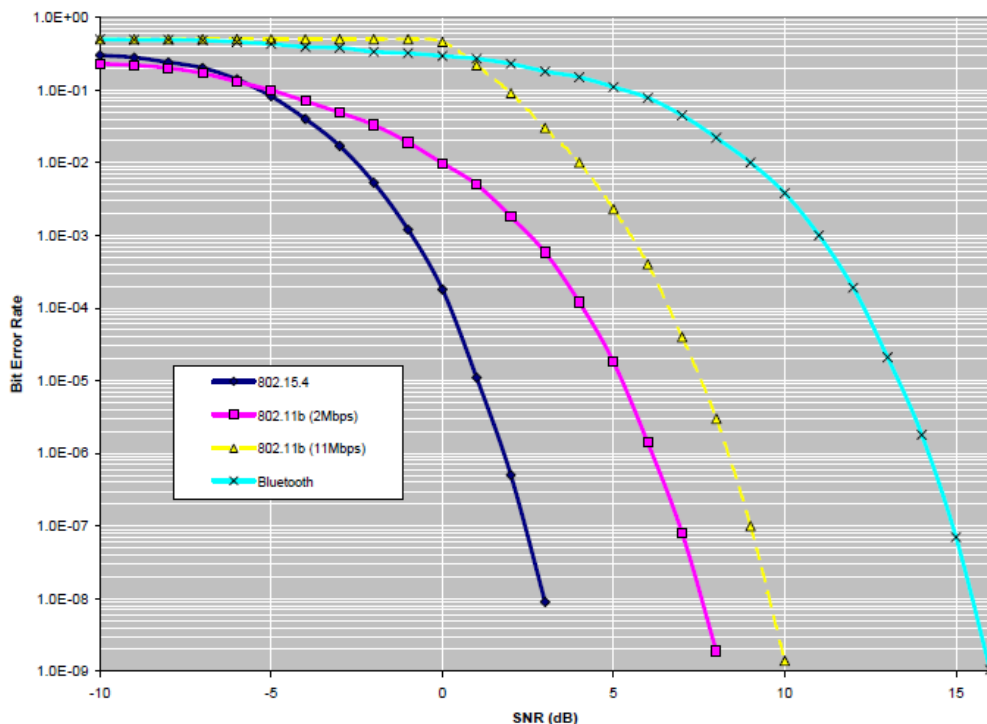

BER Results for IEEE 802.11, IEEE 802.15.1 and IEEE 802.11b

	BeanAir “Plug and Play” Wireless Sensor Network	Version : V1.0
	Cergy Pontoise	Wireless range benchmarking on BeanDevice®

6.2 PROTOCOL

The IEEE 802.15.4 standard provides several mechanisms to enhance co-existence.

6.2.1 Dynamic Channel Selection

The PHY layer provides the ability to measure the energy, and thus the interference, that is present on a particular channel. This capability is used by the MAC and higher layers to allow users to select the best available channel for operation.

6.2.2 CSMA-CA

The CSMA-CA (Carrier Sense Multiple Access with Collision Avoidance) channel access mechanism is a “listen before you talk” strategy employed by the PHY layer, providing the ability to sample a channel and report whether the channel is “Clear To Transmit”.

6.2.3 Acknowledged Transmission and Retries

To ensure successful reception of data, an acknowledged frame delivery protocol is supported to increase transfer reliability. If the receiving device is unable to handle the received data frame for any reason, the message is not acknowledged. If the originator does not receive an acknowledgment, it assumes that the transmission was unsuccessful and retries the frame transmission. This is particularly useful in dealing with frequency hopping interference, such as from Bluetooth, which may interfere with a first transmission attempt but will usually have hopped to a different part of the spectrum for the retry.

6.2.4 Data rate

While lower data-rates can meet the requirements of many applications, one of the best ways to promote co-existence is to reduce channel occupancy time. The IEEE 802.15.4-2003 standard defines the relatively high data-rate of 250 kbps for the 2.4-GHz PHY (see table IEEE 802.15.4-2003 Frequency Bands and Data Rates).

7. PRESENTATION OF THE TESTS

7.1 BEANDEVICE® ANTENNA SPECIFICATION

- Beandevicé® Ecosensor : 1 dBi Ceramic antenna (2.45 GHz)

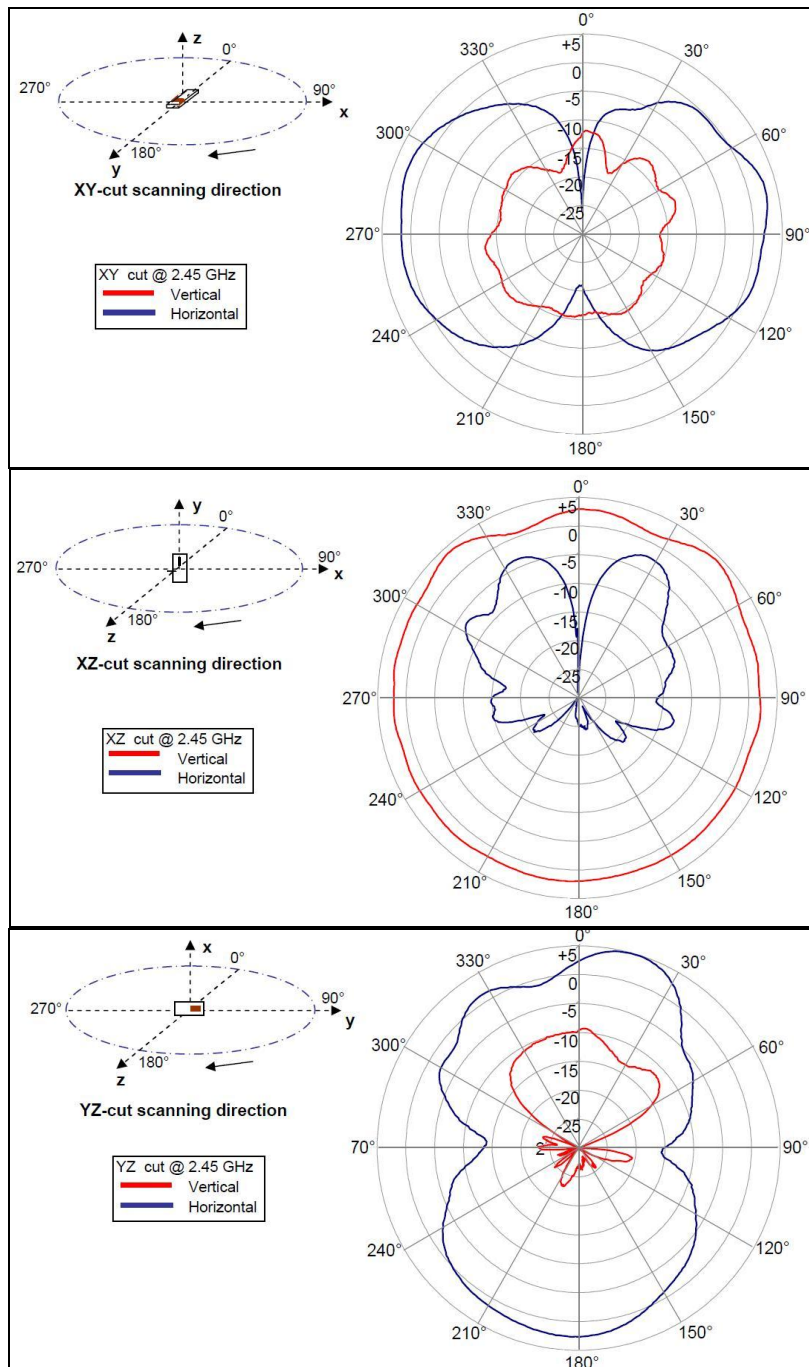

7.2 BEANGATEWAY® ANTENNA CHARACTERISTICS

Only one type of antenna was used on the BeanGateway®:

- Omnidirectional antenna with a gain of 5,5 dBi

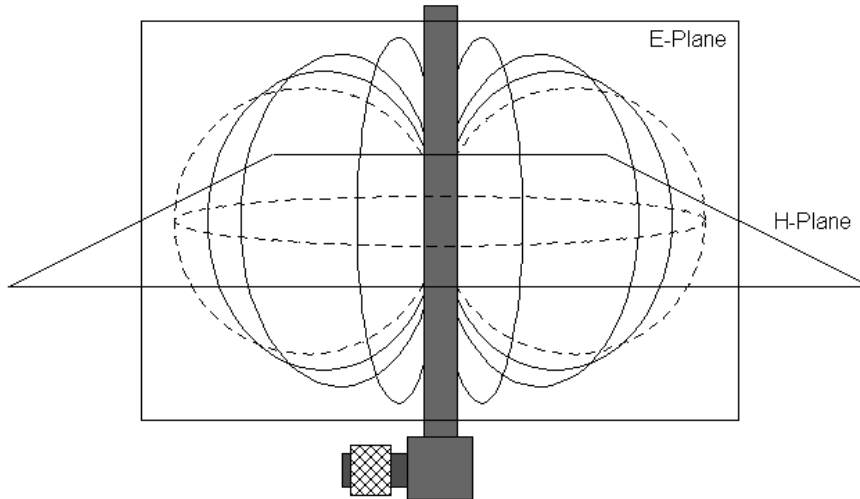

- Reference : RF_OM_5
- Gain at 2400 MHz : 5.5 dBi
- 2.4 GHz < Frequency < 2485 MHz
- Bandwidth : 83.5 MHz
- Impedance : 50 Ω
- Power max : 25 W
- VSWR < 2.0
- RP-SMA Connector

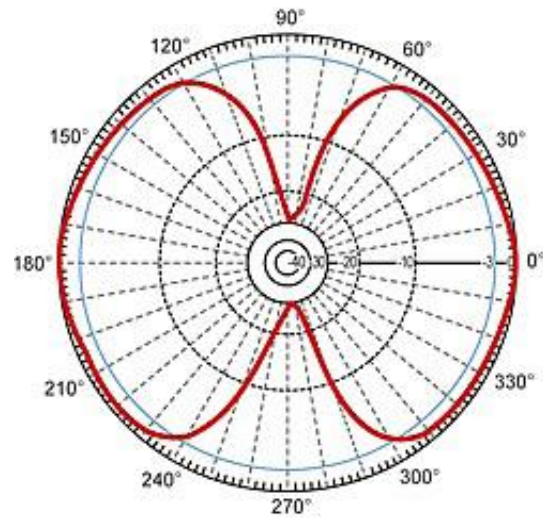

E-Plane Pattern

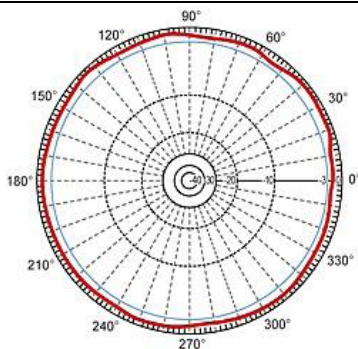

H-Plane Pattern

	BeanAir "Plug and Play" Wireless Sensor Network	Version : V1.0
	Cergy Pontoise	Wireless range benchmarking on BeanDevice®

8. GLOBAL INSTALLATION

- Two different types of wireless equipment is used for these tests :
 - WIFI network
 - Beanair® Wireless network.

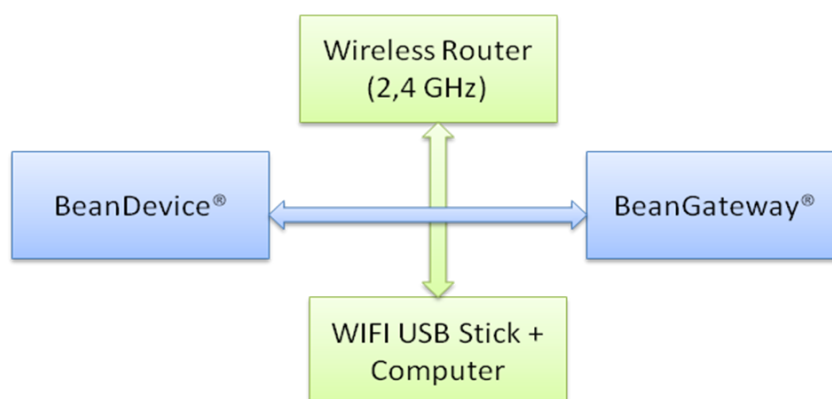

- The BeanDevice® and the BeanGateway® are installed in LOS.
- The tests are made in an opened area, so other unknown WIFI networks can be part of the global WIFI network.
- For each battery of tests, we used different positions of the BeanDevice® in reference to the BeanGateway®.

These tests will not represent all the end user application cases.

Technical Equipment Used:

- **BeanDevice Ecosensor® SUN-T**
- **BeanGateway® Indoor version**
- **BeanScope®**
- **WIFI Router : D-Link DAP-1160**

- | |
|---|
| <ul style="list-style-type: none"> ○ IEEE 802.11g ○ Ethernet 10/100 Mbps ○ Frequency Range : 2.4 ~ 2.4835 GHz ○ Wireless Transmit Power : +20 dBm (100mW) |
|---|

- **WIFI USB Stick : ALFA Network AWUS036NEH**

- | |
|--|
| <ul style="list-style-type: none"> ○ Wi-Fi IEEE 802.11b/g/n ○ 802.11b/g/n : 11Mbps / 54Mbps / 150Mbps ○ 802.11b/g/n : 2.412GHz ~ 2.484GHz ○ Wireless Transmit Power : +30dBm (1000mW) ○ Reception max : -92 dBm |
|--|



9. REACTION WITH ADJACENT CHANNELS (ON SHORT DURATION)

9.1 DISTANCE BETWEEN THE BEANDEVICE® AND THE BEANGATEWAY® = 1 METER

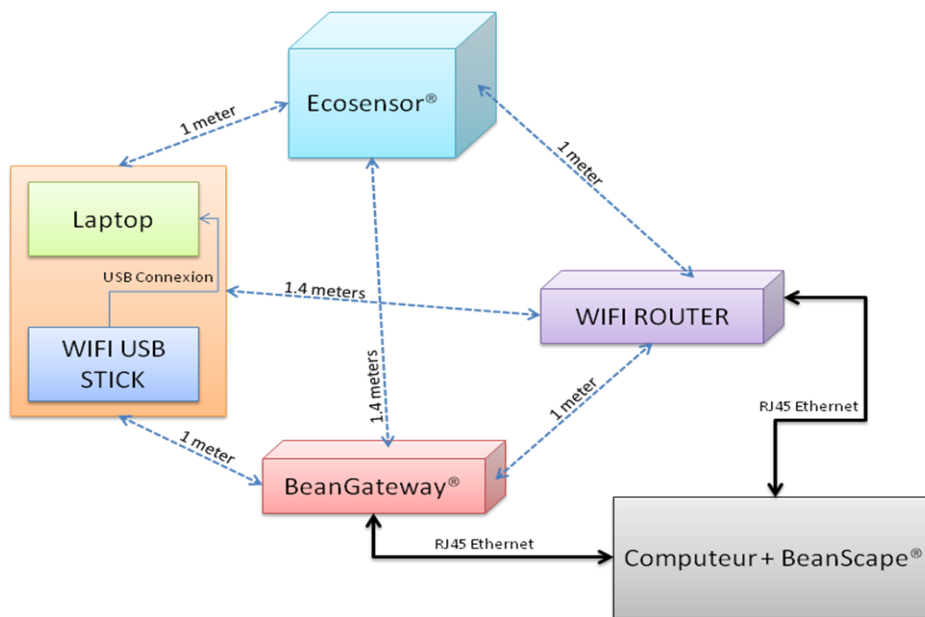

Tests Plan :

- FTP network protocol (WIFI)
 - Files sizes : 700 Mb
- FTP network protocol duration : 400 seconds
- Data Acquisition Cycle : every 4 seconds
- Diagnostic Cycle : every 4 seconds
- Network Listening Mode : every 4 seconds
- BeanDevice®'s TX Power: -7dBm ; +5dBm ; +18dBm

Test Results:

1 meter	BEANDEVICE® RF POWER																	
	-7 dBm						5 dBm						18 dBm					
WIFI Channel	1	13	1	7	11	13	1	13	1	7	11	13	1	13	1	7	11	13
IEEE 802.15.4 Channel	12	25	15	16	25	22	12	25	15	16	25	22	12	25	15	16	25	22
PER (%)	20	9,8	2,3	2,4	2	2,3	17	8,9	0	0	0	0	10	8,4	0	0	0	0
LQI	132	128	144	152	148	137	186	174	186	174	181	182	228	199	203	197	217	222

- For each case the FTP data transfer duration of 400 seconds.
- Global test duration: 2 Hours.

9.2 DISTANCE BETWEEN THE BEANDEVICE® AND THE BEANGATEWAY® = 5 METERS

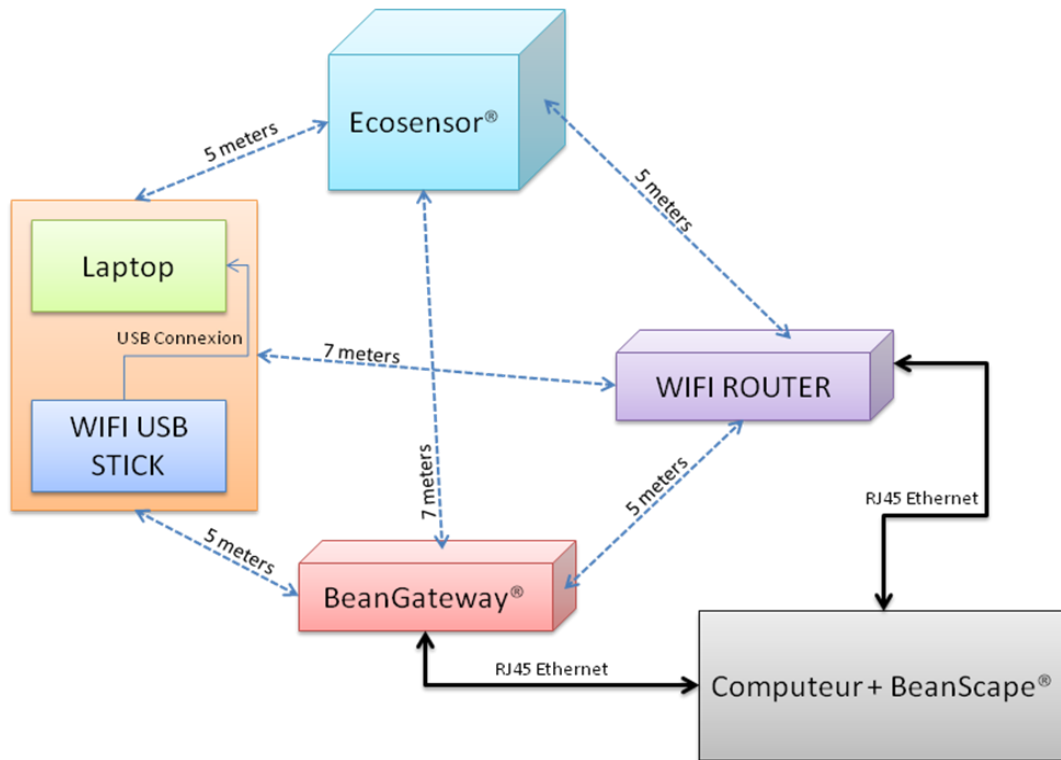

Tests Plan :

- FTP network protocol (WIFI)
 - Files sizes : 700 Mb
- FTP network protocol duration : 400 seconds
- Data Acquisition Cycle : every 4 seconds
- Diagnostic Cycle : every 4 seconds
- Network Listening Mode : every 4 seconds
- BeanDevice®'s TX Power: -7dBm ; +5dBm ; +18dBm

Test Results:

5 meters	BEANDEVICE® RF POWER																	
	-7 dBm						5 dBm						18 dBm					
WIFI Channel	1	13	1	7	11	13	1	13	1	7	11	13	1	13	1	7	11	13
IEEE 802.15.4 Channel	12	25	15	16	25	22	12	25	15	16	25	22	12	25	15	16	25	22
PER (%)	13.1	8.8	0.52	0	0.69	0	6.8	2.5	0	0	0	0	0.52	1.1	0	0	0	0
LQI	126	150	114	120	124	108	186	198	175	180	179	179	198	222	192	210	211	180

- For each case the FTP data transfer duration of 400 seconds.
- Global test duration: 2 Hours.

9.3 DISTANCE BETWEEN THE BEANDEVICE® AND THE BEANGATEWAY® = 12 METERS

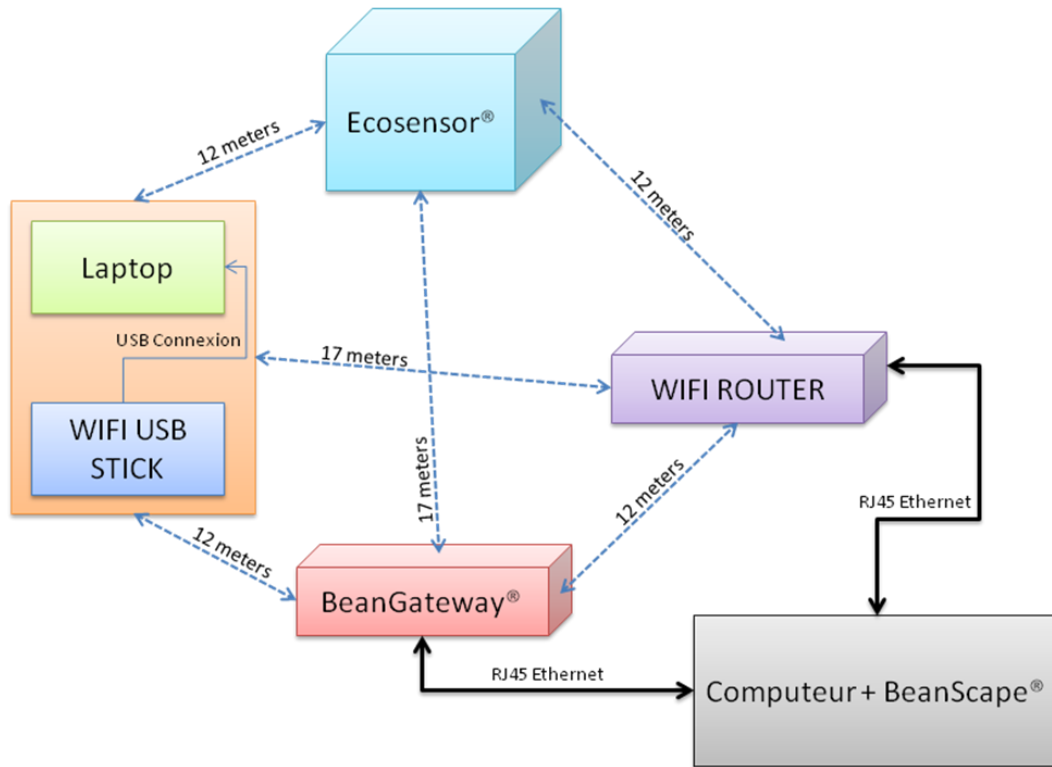

Tests Plan :

- FTP protocol (WIFI)
 - Files sizes : 700 Mb
- FTP data transfer duration : 400 seconds
- Data Acquisition Cycle : every 4 seconds
- Diagnostic Cycle : every 4 seconds
- Network Listening Mode : every 4 seconds
- BeanDevice®'s RF Power used : -7dBm ; +5dBm ; +18dBm

Test Results:

12 meters	BEANDEVICE® RF POWER																	
	-7 dBm						5 dBm						18 dBm					
WIFI Channel	1	13	1	7	11	13	1	13	1	7	11	13	1	13	1	7	11	13
IEEE 802.15.4 Channel	12	25	15	16	25	22	12	25	15	16	25	22	12	25	15	16	25	22
PER (%)	3.1	1	0	0	0	0	0.75	0.7	0	0	0	0	0.25	0.4	0	0	0	0
LQI	126	138	144	123	138	137	192	180	191	185	186	178	222	216	220	222	210	215

- For each case the FTP data transfer duration of 400 seconds.
- Global test duration: 2 Hours.

10. SYSTEM BEHAVIOUR WITH ADJACENT CHANNELS (ON LONG DURATION)

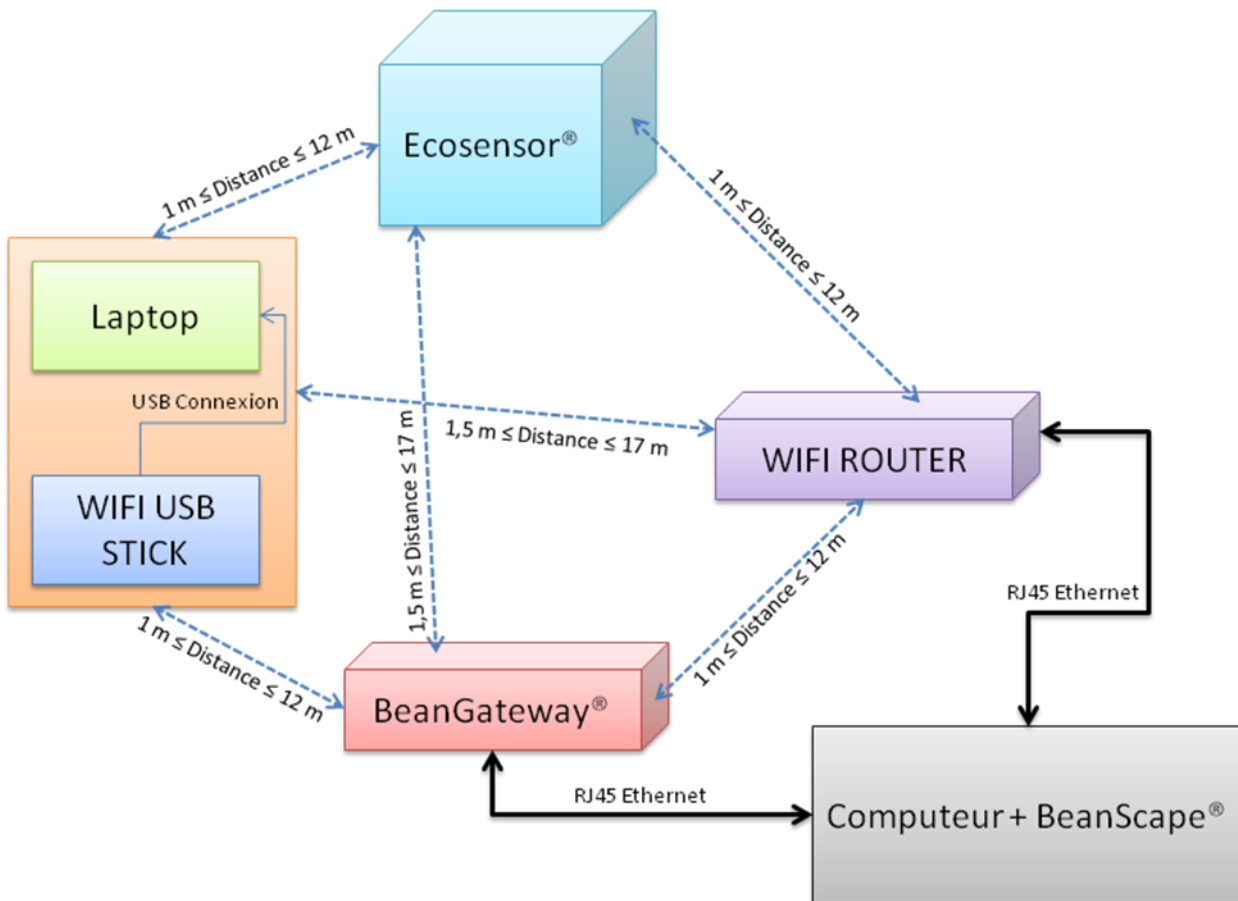

Test Plan :

- FTP network protocol (WIFI)
 - Files sizes : more than 20000 Mb (Long transfer simulation)
- FTP network protocol duration : 7800 seconds
- Data Acquisition Cycle : every 4 seconds
- Diagnostic Cycle : every 4 seconds
- Network Listening Mode : every 4 seconds
- BeanDevice®'s RF Power: +15 dBm

Tests Results :

	WIFI Channel = 11		
	IEEE 802.15.4 Channel = 25		
	Distance between the BeanGateway® and the BeanDevice® (m)	LQI	PER (%)
+ 18 dBm	1	240	0,45
	5	211	0,08
	12	185	0,02

- Almost no BeanDevice®'s data loss is detected.
- The BeanDevice® LQI remains satisfying in a very dense WIFI network.

	WIFI Channel = 11		
	IEEE 802.15.4 Channel = 25		
	Distance between the BeanGateway® and the BeanDevice® (m)	LQI	PER (%)
+ 15 dBm	1	215	0.7
	5	189	0.15
	12	173	0.03

- Almost no BeanDevice®'s data loss is detected.
- The BeanDevice® LQI remains satisfying in a very dense WIFI network.

	WIFI Channel = 11		
	IEEE 802.15.4 Channel = 25		
	Range (m)	LQI	PER (%)
-7 dBm	1	135	55

- With a very low RF Power configuration, the BeanDevice® PER is 55%

We suggest to:



- Configure the BeanDevice® with a minimum TX Power of +5 dBm.
- Respect a minimum distance of 5 meters between Beanair equipments and Wi-Fi equipment.

	BeanAir “Plug and Play” Wireless Sensor Network	Version : V1.0
	Cergy Pontoise	Wireless range benchmarking on BeanDevice®

11. CONCLUSION OF THE TESTS



- Configure your BeanDevice® with a maximum RF Power is the best compromise between the assurance of a good transmission of wireless data and battery autonomy.
- Avoid using the BeanDevice® in a dense WI-FI network. The data transmissions loss (PER) will be highly reduced.
- If the Beandevicé® is deployed in a dense WIFI network, you should configure it with a minimum TX Power of 5 dBm RF Power.
- Do not hesitate to make an Energy Scan via the BeanScope and then select the most efficient channel.
*For more information, check the document:
Cf: User Manuel BeanGateway V1.6, section 8.7.5 “Energy Scan”*
- Take care of the antenna’s orientation. You could possibly obtain a better LQI and PER, depending on how’s the antenna’s position.
Refer you to the chapter 7: Presentation of tests.